















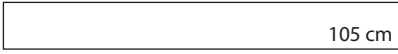

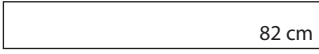



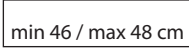

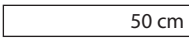





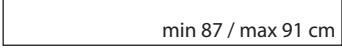



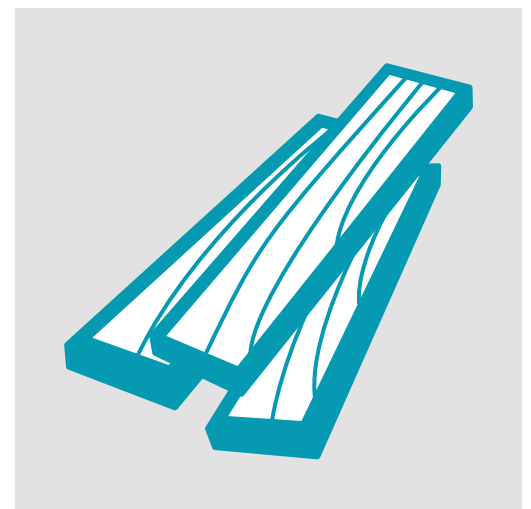
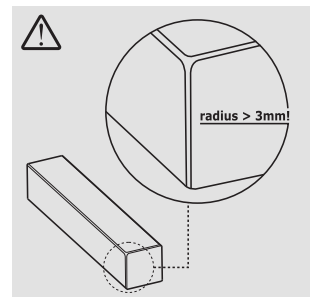
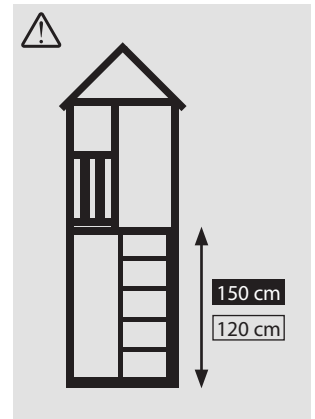

















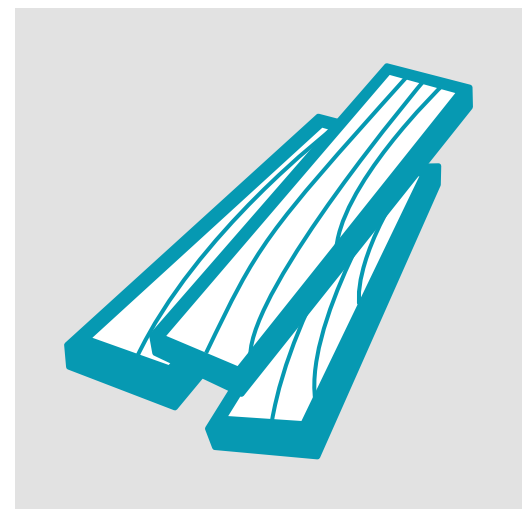











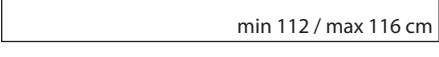



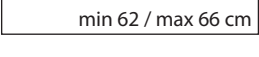

- 4x** **A** min 68 mm | max 90 mm   240 cm | 270 cm  
min 68 mm | max 90 mm
- 2x** **B** min 68 mm | max 90 mm   127 cm  
min 68 mm | max 90 mm
- 2x** **C** min 68 mm | max 90 mm   134 cm | 166 cm  
min 32 mm | max 50 mm
- 9x** **D** min 68 mm | max 90 mm   105 cm  
min 32 mm | max 50 mm
- 2x** **E** min 68 mm | max 90 mm   82 cm  
min 32 mm | max 50 mm
- 2x** **F** min 68 mm | max 90 mm   min 73 / max 75 cm  
min 32 mm | max 50 mm
- 4x** **G** min 68 mm | max 90 mm   min 46 / max 48 cm  
min 32 mm | max 50 mm
- 3x 4x** **H** min 44 mm | max 45 mm   50 cm  
min 44 mm | max 45 mm
- 12x\*/18x\*\*** **I** \*\* min 95 mm | \* max 145 mm   130 cm  
min 15 mm | max 22 mm
- 6x** **J** min 95 mm | max 145 mm   105 cm  
min 15 mm | max 22 mm
- 8x\*/12x\*\*** **K** \*\* min 95 mm | \* max 145 mm   min 87 / max 91 cm  
min 15 mm | max 22 mm
- 12x\*/16x\*\*** **L** \*\* min 95 mm | \* max 145 mm   69 cm  
min 15 mm | max 22 mm
- 2x** **M** min 95 mm | max 145 mm   40 cm  
min 15 mm | max 22 mm



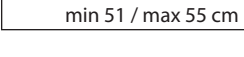

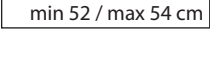

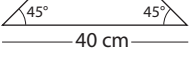

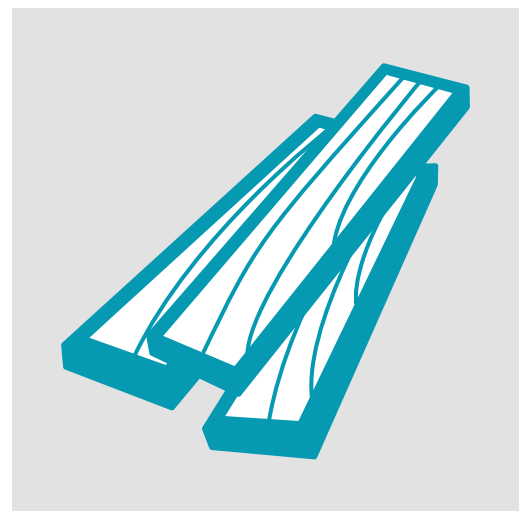
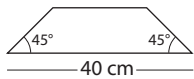

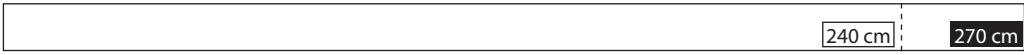







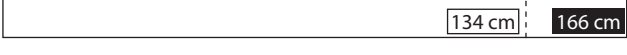





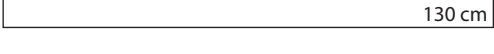

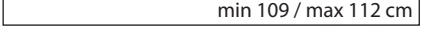

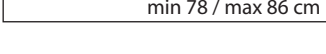

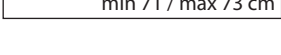

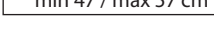

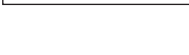

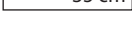
5x	<b>A</b>	min 68 mm max 90 mm		270 cm
		min 68 mm max 90 mm		
4x	<b>B</b>	min 68 mm max 90 mm		192 cm
		min 68 mm max 90 mm		
2x	<b>C</b>	min 68 mm max 90 mm		127 cm
		min 68 mm max 90 mm		
1x	<b>D</b>	min 68 mm max 90 mm		77 cm
		min 68 mm max 90 mm		
1x	<b>E</b>	min 68 mm max 90 mm		190 cm
		min 32 mm max 50 mm		
2x	<b>F</b>	min 68 mm max 90 mm		166 cm
		min 32 mm max 50 mm		
2x	<b>G</b>	min 68 mm max 90 mm		130 cm
		min 32 mm max 50 mm		
2x	<b>H</b>	min 68 mm max 90 mm		min 128 / max 130 cm
		min 32 mm max 50 mm		
6x	<b>I</b>	min 68 mm max 90 mm		120 cm
		min 32 mm max 50 mm		
2x	<b>J</b>	min 68 mm max 90 mm		95 cm
		min 32 mm max 50 mm		
2x	<b>K</b>	min 68 mm max 90 mm		min 86 / max 88 cm
		min 32 mm max 50 mm		
4x	<b>L</b>	min 68 mm max 90 mm		80 cm
		min 32 mm max 50 mm		
1x	<b>M</b>	min 68 mm max 90 mm		71 cm
		min 32 mm max 50 mm		
4x	<b>N</b>	min 68 mm max 90 mm		69 cm
		min 32 mm max 50 mm		
1x	<b>O</b>	min 68 mm max 90 mm		min 67 / max 69 cm
		min 32 mm max 50 mm		
1x	<b>P</b>	min 68 mm max 90 mm		63 cm
		min 32 mm max 50 mm		
4x	<b>Q</b>	min 68 mm max 90 mm		min 61 / max 63 cm
		min 32 mm max 50 mm		



- 4x** **R** min 44 mm | max 45 mm  
- min 44 mm  
max 45 mm
- 2x** **S** min 95 mm | max 145 mm  
- min 15 mm  
max 22 mm
- 14x\*/20x\*\*** **T** \*\* min 95 mm | \* max 145 mm  
- min 15 mm  
max 22 mm
- 6x** **U** min 95 mm | max 145 mm  
- min 15 mm  
max 22 mm
- 4x** **V** min 95 mm | max 145 mm  
- min 15 mm  
max 22 mm
- 8x\*/12x\*\*** **W** \*\* min 95 mm | \* max 145 mm  
- min 15 mm  
max 22 mm
- 17x\*/21x\*\*** **X** \*\* min 95 mm | \* max 145 mm  
- min 15 mm  
max 22 mm
- 17x\*/26x\*\*** **Y** \*\* min 95 mm | \* max 145 mm  
- min 15 mm  
max 22 mm
- 15x\*/22x\*\*** **Z** \*\* min 95 mm | \* max 145 mm  
- min 15 mm  
max 22 mm
- 1x\*/2x\*\*** **1** \*\* min 95 mm | \* max 145 mm  
- min 15 mm  
max 22 mm
- 1x** **2** min 95 mm | max 145 mm  
- min 15 mm  
max 22 mm
- 1x** **3** min 95 mm | max 145 mm  
- min 15 mm  
max 22 mm
- 2x** **4** min 95 mm | max 145 mm    
min 15 mm  
max 22 mm



2x	<b>A</b>	min 68 mm max 90 mm		
		min 68 mm max 90 mm		
2x	<b>B</b>	min 68 mm max 90 mm		
		min 68 mm max 90 mm		
1x	<b>C</b>	min 68 mm max 90 mm		
		min 68 mm max 90 mm		
1x	<b>D</b>	min 68 mm max 90 mm		
		min 68 mm max 90 mm		
2x	<b>E</b>	min 68 mm max 90 mm		
		min 32 mm max 50 mm		
2x	<b>F</b>	min 68 mm max 90 mm		
		min 32 mm max 50 mm		
7x	<b>G</b>	min 68 mm max 90 mm		
		min 32 mm max 50 mm		
6x	<b>H</b>	min 68 mm max 90 mm		
		min 32 mm max 50 mm		
1x	<b>I</b>	min 68 mm max 90 mm		
		min 32 mm max 50 mm		
2x	<b>J</b>	min 68 mm max 90 mm		
		min 32 mm max 50 mm		
2x	<b>K</b>	min 68 mm max 90 mm		
		min 32 mm max 50 mm		
2x	<b>L</b>	min 44 mm max 45 mm		
		min 44 mm max 45 mm		
3x 4x	<b>M</b>	min 44 mm max 45 mm		
		min 44 mm max 45 mm		
2x	<b>N</b>	min 44 mm max 45 mm		
		min 44 mm max 45 mm		
11x*/17x**	<b>O</b>	** min 95 mm * max 145 mm		
		min 15 mm max 22 mm		
8x*/10x**	<b>P</b>	** min 95 mm * max 145 mm		
		min 15 mm max 22 mm		
10x*/14x**	<b>Q</b>	** min 95 mm * max 145 mm		
		min 15 mm max 22 mm		
4x	<b>R</b>	min 95 mm max 145 mm		
		min 15 mm max 22 mm		

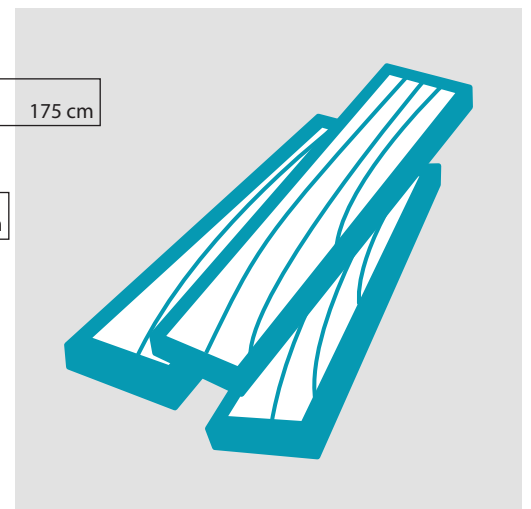
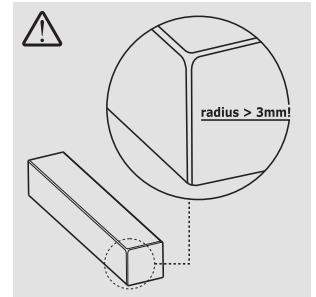
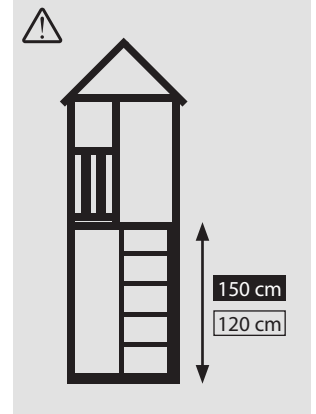

**5x\*/8x\*\*** **S** \*\* min 95 mm  
\* max 145 mm



118 cm

min 15 mm  
max 22 mm

**3x\*/4x\*\*** **T** \*\* min 95 mm  
\* max 145 mm



85 cm

min 15 mm  
max 22 mm

**4x\*/6x\*\*** **U** \*\* min 95 mm  
\* max 145 mm



69 cm

min 15 mm  
max 22 mm

**3x\*/4x\*\*** **V** \*\* min 95 mm  
\* max 145 mm



30 cm

min 15 mm  
max 22 mm

**α**

95 mm	120 mm	145 mm
-------	--------	--------

**2x** **1** **α**



122 cm	122 cm	122 cm
--------	--------	--------

min 15 mm  
max 22 mm

**2x** **2** **α**



126 cm	125 cm	128 cm
--------	--------	--------

min 15 mm  
max 22 mm

**2x** **3** **α**



130 cm	130 cm	133 cm
--------	--------	--------

min 15 mm  
max 22 mm

**2x** **4** **α**



134 cm	135 cm	139 cm
--------	--------	--------

min 15 mm  
max 22 mm

**2x** **5** **α**



137 cm	140 cm	145 cm
--------	--------	--------

min 15 mm  
max 22 mm

**2x** **6** **α**



141 cm	145 cm	-
--------	--------	---

min 15 mm  
max 22 mm









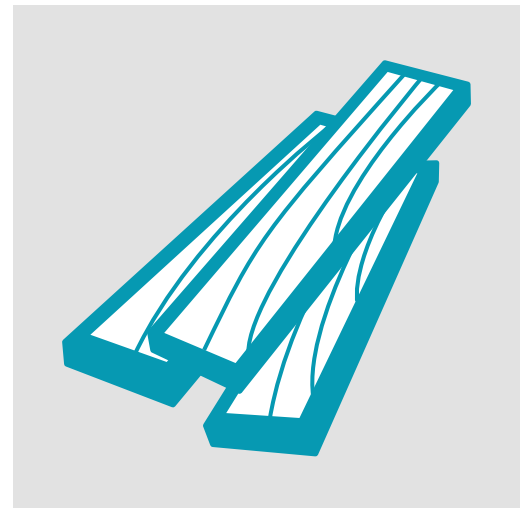



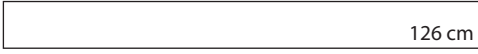







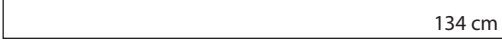









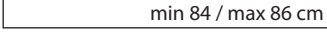

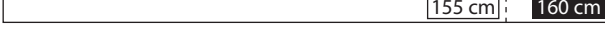

**2x** **7** **α**



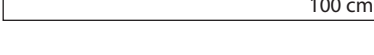

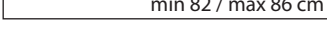
145 cm	-	-
--------	---	---

min 15 mm  
max 22 mm

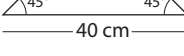

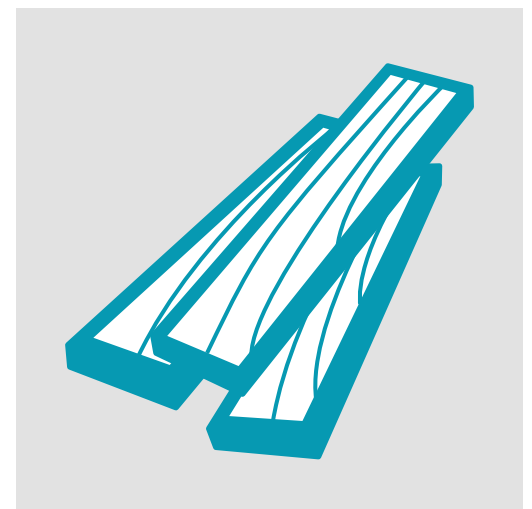
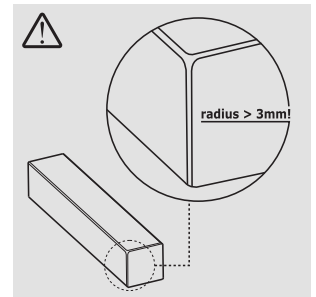
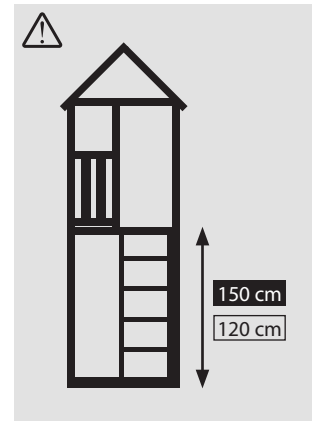

- 4x** **A** min 68 mm | max 90 mm   240 cm | 270 cm
- min 68 mm | max 90 mm
- 1x** **B** min 68 mm | max 90 mm   126 cm
- min 68 mm | max 90 mm
- 2x** **C** min 68 mm | max 90 mm   134 cm | 166 cm
- min 32 mm | max 50 mm
- 1x** **D** min 68 mm | max 90 mm   120 cm | 150 cm
- min 32 mm | max 50 mm
- 3x** **E** min 68 mm | max 90 mm   135 cm
- min 32 mm | max 50 mm
- 1x** **F** min 68 mm | max 90 mm   134 cm
- min 32 mm | max 50 mm
- 1x** **G** min 68 mm | max 90 mm   123 cm
- min 32 mm | max 50 mm
- 2x** **H** min 68 mm | max 90 mm   115 cm
- min 32 mm | max 50 mm
- 3x** **I** min 68 mm | max 90 mm   100 cm
- min 32 mm | max 50 mm
- 2x** **J** min 68 mm | max 90 mm   93 cm
- min 32 mm | max 50 mm
- 2x** **K** min 68 mm | max 90 mm   min 84 / max 86 cm
- min 32 mm | max 50 mm
- 3x 4x** **L** min 44 mm | max 45 mm   50 cm
- min 44 mm | max 45 mm
- 2x** **M** min 95 mm | max 145 mm   155 cm | 160 cm
- min 15 mm | max 22 mm
- 14x\*/20x\*\*** **N** \*\* min 95 mm | \* max 145 mm   120 cm
- min 15 mm | max 22 mm
- 13x\*/18x\*\*** **O** \*\* min 95 mm | \* max 145 mm   100 cm
- min 15 mm | max 22 mm
- 10x\*/15x\*\*** **P** \*\* min 95 mm | \* max 145 mm   min 82 / max 86 cm
- min 15 mm | max 22 mm
- 10x\*/13x\*\*** **Q** \*\* min 95 mm | \* max 145 mm   69 cm
- min 15 mm | max 22 mm
- 2x** **R** min 95 mm | max 145 mm   40 cm
- min 15 mm | max 22 mm





- 2x** **A** min 68 mm | max 90 mm  230 cm 260 cm

min 68 mm  
max 90 mm
- 2x** **B** min 68 mm | max 90 mm  210 cm 240 cm

min 68 mm  
max 90 mm
- 2x** **C** min 68 mm | max 90 mm  120 cm 150 cm

min 68 mm  
max 90 mm
- 1x** **D** min 68 mm | max 90 mm  90 cm 120 cm

min 68 mm  
max 90 mm
- 1x** **E** min 68 mm | max 90 mm  77 cm

min 68 mm  
max 90 mm
- 7x** **F** min 68 mm | max 90 mm  105 cm

min 32 mm  
max 50 mm
- 6x** **G** min 68 mm | max 90 mm  95 cm

min 32 mm  
max 50 mm
- 5x** **H** min 68 mm | max 90 mm  69 cm

min 32 mm  
max 50 mm
- 3x** **I** min 68 mm | max 90 mm  min 51 / max 55 cm

min 32 mm  
max 50 mm
- 1x** **J** min 68 mm | max 90 mm  50 cm

min 32 mm  
max 50 mm
- 1x** **K** min 68 mm | max 90 mm  min 32 cm  
max 35 cm

min 32 mm  
max 50 mm
- 8x\*/11x\*\*** **L** \*\* min 95 mm | \* max 145 mm  120 cm

min 15 mm  
max 22 mm
- 4x** **M** min 95 mm | max 145 mm  105 cm

min 15 mm  
max 22 mm
- 2x** **N** min 95 mm | max 145 mm  95 cm









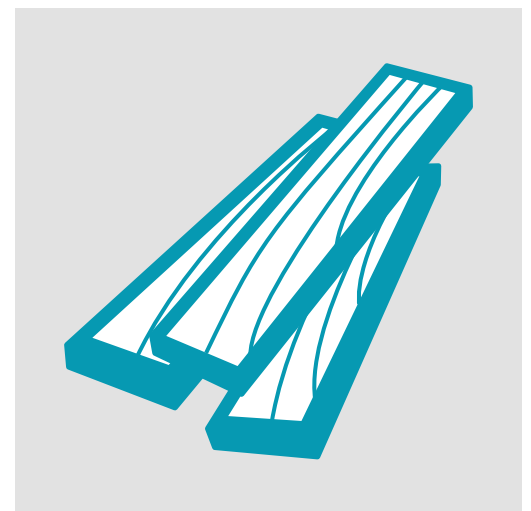
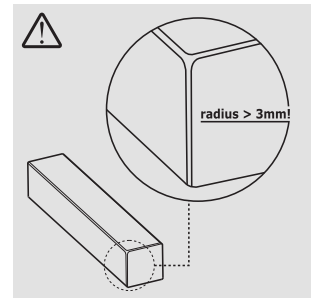
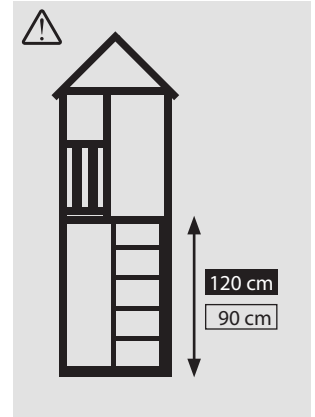









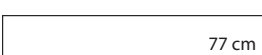







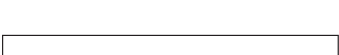











min 15 mm  
max 22 mm
- 7x\*/11x\*\*** **O** \*\* min 95 mm | \* max 145 mm  min 87 / max 91 cm

min 15 mm  
max 22 mm
- 16x\*/19x\*\*** **P** \*\* min 95 mm | \* max 145 mm  69 cm

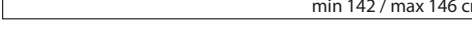
min 15 mm  
max 22 mm
- 11x\*/17x\*\*** **Q** \*\* min 95 mm | \* max 145 mm  min 51 / max 55 cm

min 15 mm  
max 22 mm



- 2x** **A** min 68 mm | max 90 mm  
  - min 68 mm
  - max 90 mm
- 3x** **B** min 68 mm | max 90 mm  
  - min 68 mm
  - max 90 mm
- 1x** **C** min 68 mm | max 90 mm  
  - min 68 mm
  - max 90 mm
- 2x** **D** min 68 mm | max 90 mm  
  - min 68 mm
  - max 90 mm
- 1x** **E** min 68 mm | max 90 mm  
  - min 68 mm
  - max 90 mm
- 2x** **F** min 68 mm | max 90 mm  
  - min 32 mm
  - max 50 mm
- 4x** **G** min 68 mm | max 90 mm  
  - min 32 mm
  - max 50 mm
- 6x** **H** min 68 mm | max 90 mm  
  - min 32 mm
  - max 50 mm
- 2x** **I** min 68 mm | max 90 mm  
  - min 32 mm
  - max 50 mm
- 2x** **J** min 68 mm | max 90 mm  
  - min 32 mm
  - max 50 mm
- 2x** **K** min 68 mm | max 90 mm  
  - min 32 mm
  - max 50 mm
- 4x** **L** min 68 mm | max 90 mm  
  - min 32 mm
  - max 50 mm
- 3x 4x** **M** min 44 mm | max 45 mm  
  - min 44 mm
  - max 45 mm
- 3x 4x** **N** min 44 mm | max 45 mm  
  - min 44 mm
  - max 45 mm
- 6x** **O** min 95 mm | max 145 mm  
  - min 15 mm
  - max 22 mm
- 10x\*/15x\*\*** **P** \*\* min 95 mm | \* max 145 mm  
  - min 15 mm
  - max 22 mm
- 4x** **Q** min 95 mm | max 145 mm  
  - min 15 mm
  - max 22 mm
- 16x\*/24x\*\*** **R** \*\* min 95 mm | \* max 145 mm  
  - min 15 mm
  - max 22 mm
- 15x\*/20x\*\*** **S** \*\* min 95 mm | \* max 145 mm  
  - min 15 mm
  - max 22 mm
- 2x** **T** min 95 mm | max 145 mm  
  - min 15 mm
  - max 22 mm

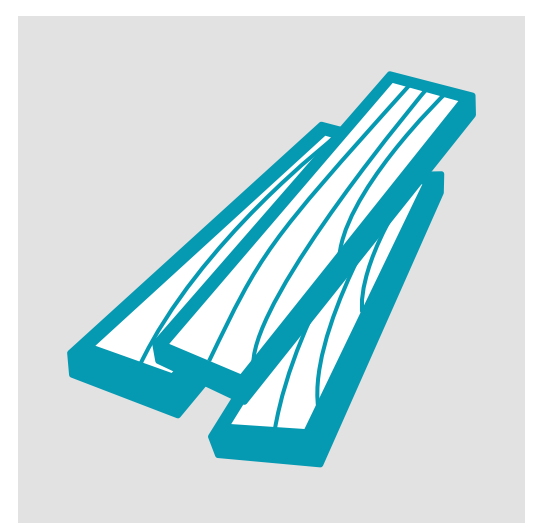
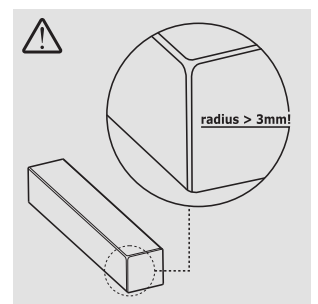
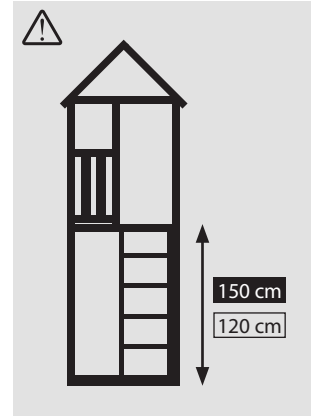



1x



min 88 mm max 90 mm

4x



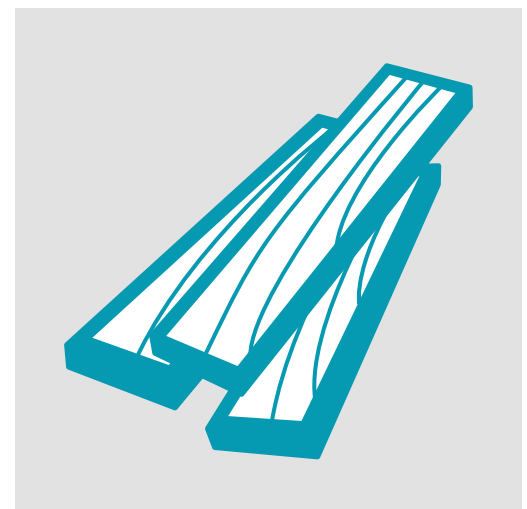
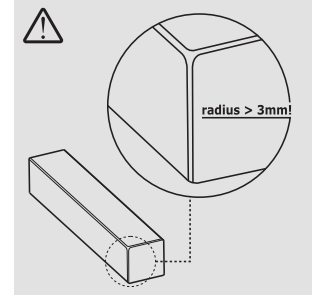
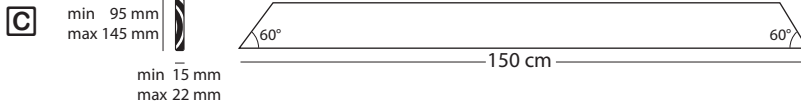

min 68 mm max 90 mm

2x



**1x** **A** min 88 mm | max 90 mm   270 cm

min 88 mm  
max 90 mm

**6x** **B** min 68 mm | max 90 mm   240 cm

min 68 mm  
max 90 mm

**2x** **C** min 68 mm | max 90 mm   126 cm



min 32 mm  
max 50 mm

**3x** **D** min 44 mm | max 45 mm   min 63 / max 68 cm

min 44 mm  
max 45 mm

**1x** **E** min 95 mm | max 145 mm   150 cm

min 15 mm  
max 22 mm

**9x\*/14\*\*x** **L** \*\* min 95 mm | \* max 145 mm   50 cm

min 15 mm  
max 22 mm

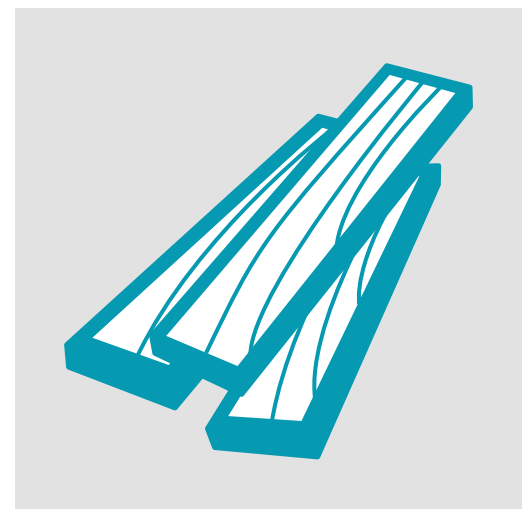
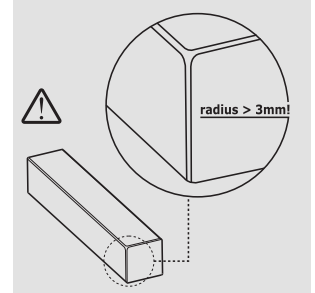

2x

**A** min 68 mm  
max 90 mm



min 32 mm  
max 50 mm

9x\*/17x\*\*

**B** \*\* min 95 mm  
\* max 145 mm



min 15 mm  
max 22 mm

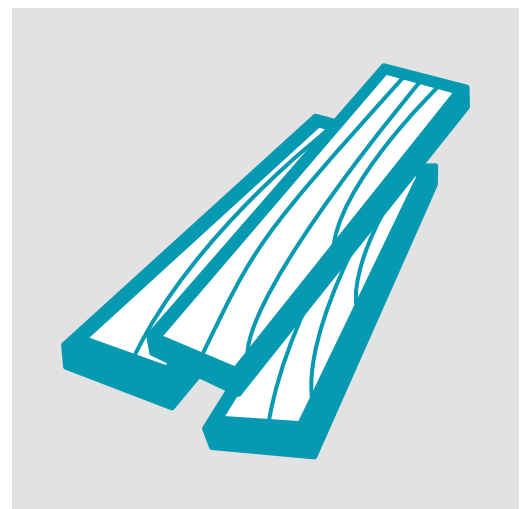
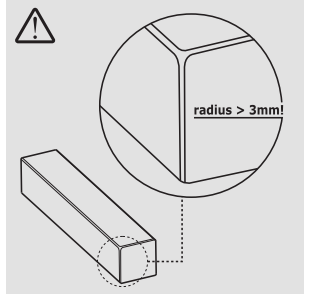
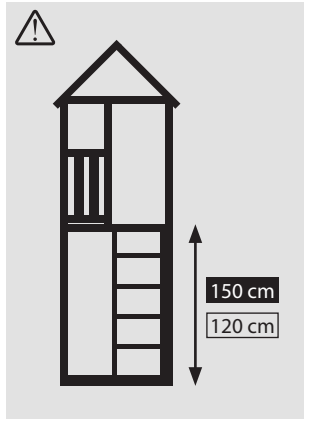

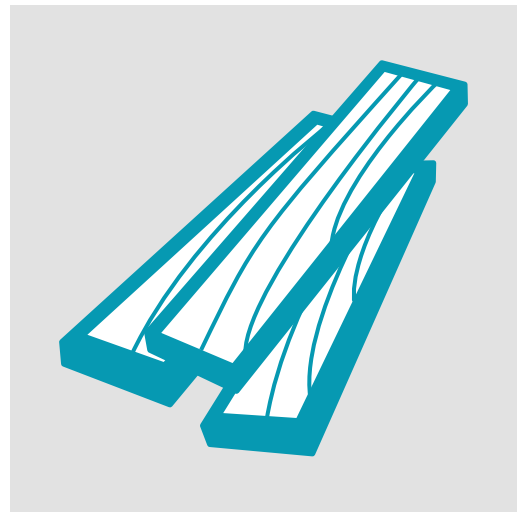
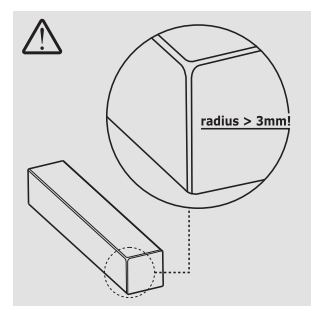
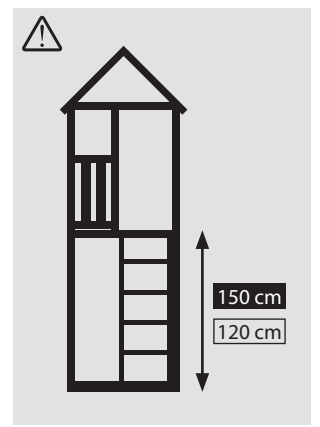
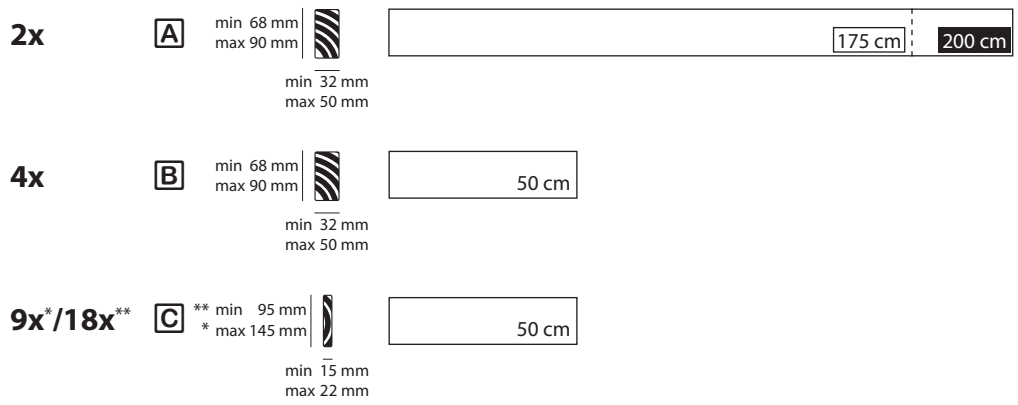

no wood required

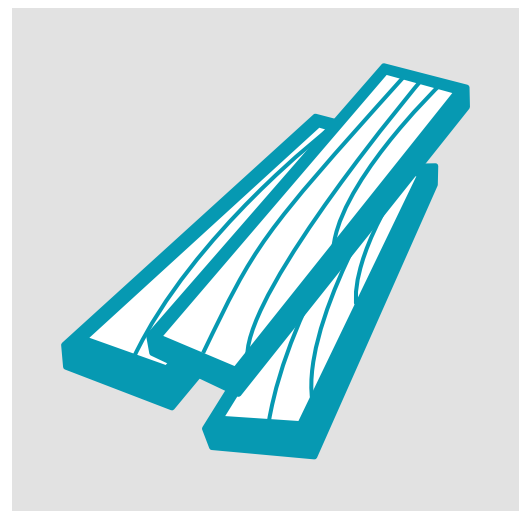

2x **A** min 68 mm max 70 mm  213 cm

min 68 mm  
max 70 mm

2x **B** min 68 mm max 70 mm  200 cm

min 68 mm  
max 70 mm

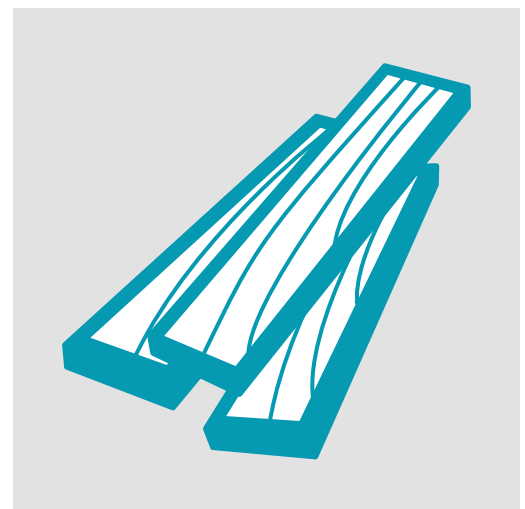
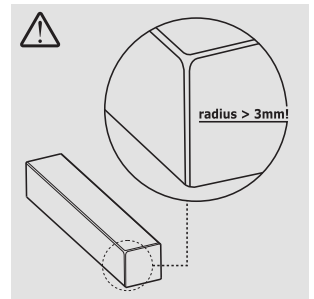

1x



min 88 mm max 90 mm

2x



min 68 mm max 90 mm

1x

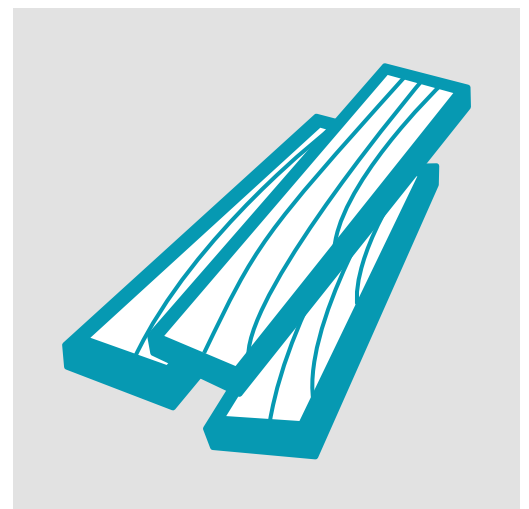
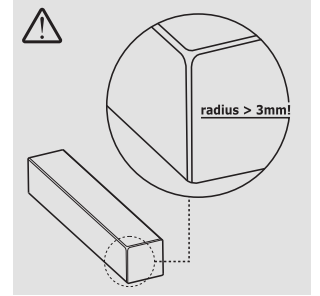
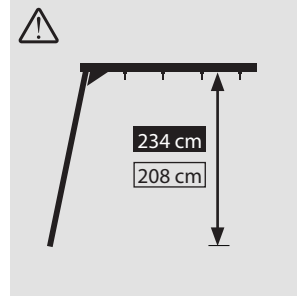
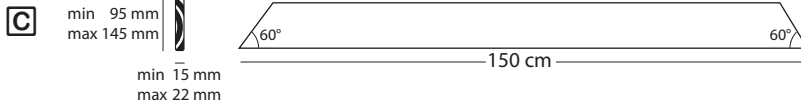

**1x** **A** min 68 mm max 90 mm   120 cm 150 cm

min 68 mm  
max 90 mm

**2x** **B** min 68 mm max 90 mm   120 cm

min 68 mm  
max 90 mm

**3x** **C** min 68 mm max 90 mm   73 cm

min 32 mm  
max 50 mm

**5x** **D** min 68 mm max 90 mm   65 cm



min 32 mm  
max 50 mm

**2x** **E** min 95 mm max 145 mm   73 cm

min 15 mm  
max 22 mm

**5x\*/7x\*\*** **F** \*\* min 95 mm \* max 145 mm   min 55 / max 59 cm

min 15 mm  
max 22 mm

**6x\*/8x\*\*** **G** \*\* min 95 mm \* max 145 mm   45 cm

min 15 mm  
max 22 mm

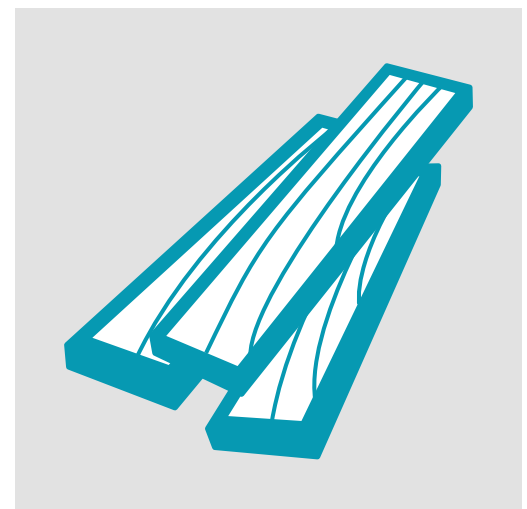
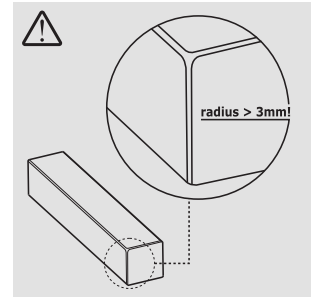
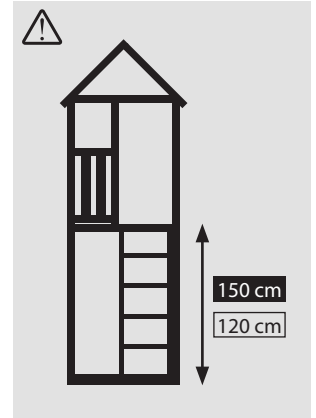





- 1x** **A** min 88 mm |  max 90 mm 240 cm | 270 cm

min 88 mm  
max 90 mm
- 2x** **B** min 68 mm |  max 90 mm 240 cm | 270 cm

min 68 mm  
max 90 mm
- 2x** **C** min 68 mm |  max 90 mm 210 cm | 240 cm

min 68 mm  
max 90 mm
- 1x** **D** min 68 mm |  max 90 mm 127 cm | 157 cm

min 68 mm  
max 90 mm
- 2x** **E** min 68 mm |  max 90 mm 125 cm

min 32 mm  
max 50 mm
- 6x 7x** **F** min 68 mm |  max 90 mm 93 cm

min 32 mm  
max 50 mm
- 1x** **G** min 68 mm |  max 90 mm min 75 / max 79 cm

min 32 mm  
max 50 mm
- 1x** **H** min 68 mm |  max 90 mm 45 cm



min 32 mm  
max 50 mm
- 10x\*/15x\*\***  
**12x\*/18x\*\*** **I** \*\* min 95 mm |  max 145 mm 93 cm

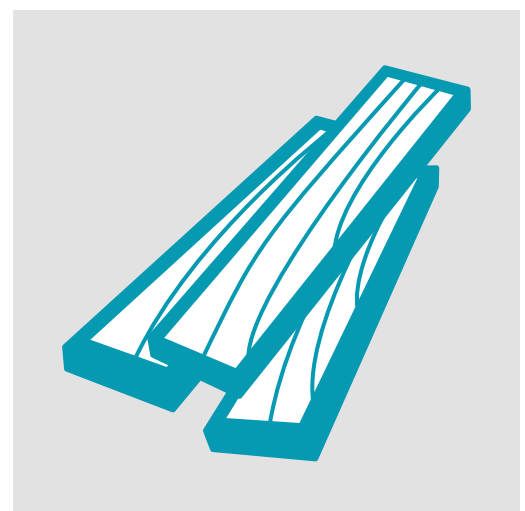
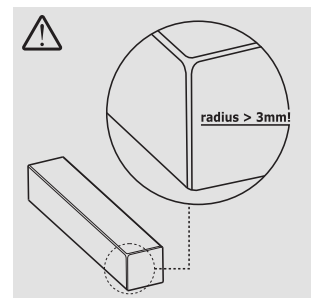
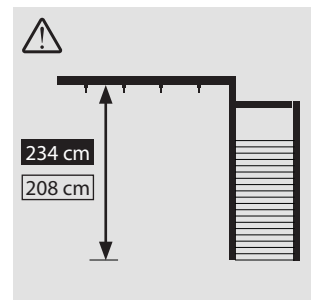

min 15 mm  
max 22 mm
- 7x\*/10x\*\***  
**8x\*/12x\*\*** **J** \*\* min 95 mm |  max 145 mm min 75 / max 79 cm

min 15 mm  
max 22 mm
- 2x** **K** min 95 mm |  max 145 mm 45°  
-17 cm-

min 15 mm  
max 22 mm



- 2x** **A** min 68 mm | max 90 mm   90 cm



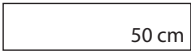

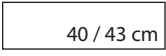



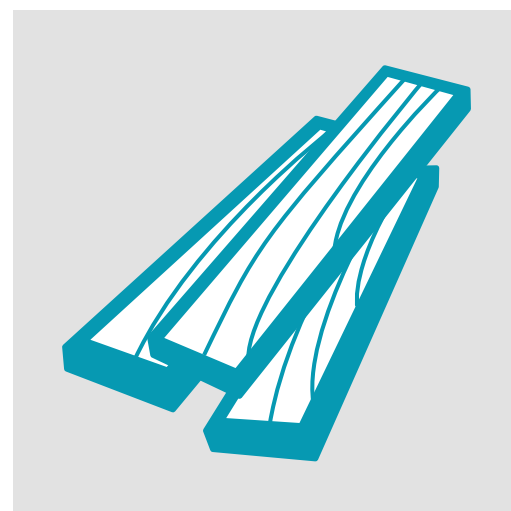
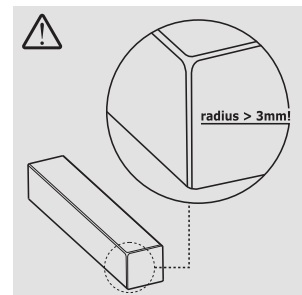
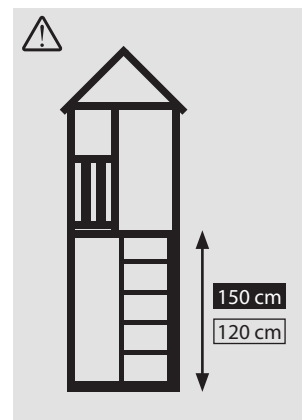













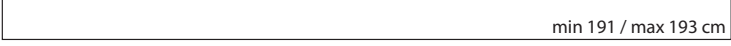





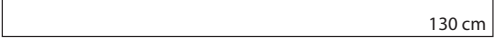

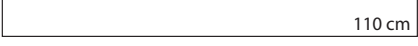



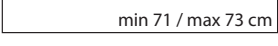

min 68 mm | max 90 mm
- 4x** **B** min 68 mm | max 90 mm   145 cm | 175 cm

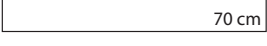
min 32 mm | max 50 mm
- 2x** **C** min 95 mm | max 145 mm   50 cm

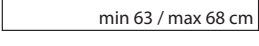
min 15 mm | max 22 mm
- 7x** **D** min 95 mm | max 145 mm   40 / 43 cm

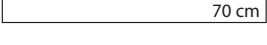
min 15 mm | max 22 mm

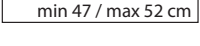

7x	A	min 68 mm max 90 mm			270 cm
				min 68 mm max 90 mm	
1x	B	min 68 mm max 90 mm			240 cm
				min 68 mm max 90 mm	
1x	C	min 68 mm max 90 mm			221 cm
				min 68 mm max 90 mm	
2x	D	min 68 mm max 90 mm			127 cm
				min 68 mm max 90 mm	
2x	E	min 68 mm max 90 mm			110 cm
				min 68 mm max 90 mm	
1x	F	min 68 mm max 90 mm			min 231 / max 233 cm
				min 32 mm max 50 mm	
3x	G	min 68 mm max 90 mm			min 191 / max 193 cm
				min 32 mm max 50 mm	
2x	H	min 68 mm max 90 mm			min 172 / max 176 cm
				min 32 mm max 50 mm	
2x	I	min 68 mm max 90 mm			166 cm
				min 32 mm max 50 mm	
11x	J	min 68 mm max 90 mm			130 cm
				min 32 mm max 50 mm	
9x	K	min 68 mm max 90 mm			110 cm
				min 32 mm max 50 mm	
2x	L	min 68 mm max 90 mm			95 cm
				min 32 mm max 50 mm	
2x	M	min 68 mm max 90 mm			min 86 / max 88 cm
				min 32 mm max 50 mm	
2x	N	min 68 mm max 90 mm			min 71 / max 73 cm
				min 32 mm max 50 mm	
2x	O	min 68 mm max 90 mm			70 cm
				min 32 mm max 50 mm	
1x	P	min 68 mm max 90 mm			min 63 / max 68 cm
				min 32 mm max 50 mm	
5x	Q	min 44 mm max 45 mm			70 cm
				min 44 mm max 45 mm	
2x	R	min 44 mm max 45 mm			min 47 / max 52 cm
				min 44 mm max 45 mm	
4x	S	min 44 mm max 45 mm			50 cm
				min 44 mm max 45 mm	

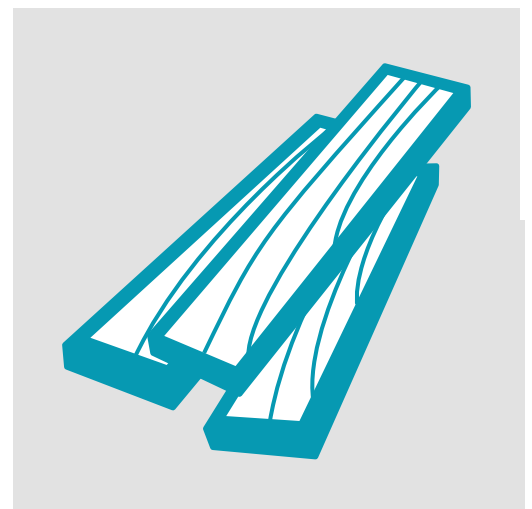

<b>1x</b>	<b>T</b>	min 44 mm max 45 mm		7 cm	
<b>1x</b>	<b>U</b>	min 95 mm max 145 mm		min 231 / max 233 cm	
<b>2x</b>	<b>V</b>	min 95 mm max 145 mm		min 15 mm max 22 mm	min 191 / max 193 cm
<b>22x*/32x**</b>	<b>W</b>	** min 95 mm * max 145 mm		min 15 mm max 22 mm	143 cm
<b>13x*/17x**</b>	<b>X</b>	** min 95 mm * max 145 mm		min 15 mm max 22 mm	130 cm
<b>9x*/13x**</b>	<b>Y</b>	** min 95 mm * max 145 mm		min 15 mm max 22 mm	min 112 / max 116 cm
<b>20x*/27x**</b>	<b>Z</b>	** min 95 mm * max 145 mm		min 15 mm max 22 mm	110 cm
<b>4x*/6x**</b>	<b>a</b>	** min 95 mm * max 145 mm		min 15 mm max 22 mm	105 cm
<b>4x*/6x**</b>	<b>b</b>	** min 95 mm * max 145 mm		min 15 mm max 22 mm	98 cm
<b>21x*/29x**</b>	<b>c</b>	** min 95 mm * max 145 mm		min 15 mm max 22 mm	min 92 / max 96 cm
<b>16x*/22x**</b>	<b>d</b>	** min 95 mm * max 145 mm		min 15 mm max 22 mm	70 cm
<b>19x*/25x**</b>	<b>e</b>	** min 95 mm * max 145 mm		min 15 mm max 22 mm	69 cm
<b>2x</b>	<b>f</b>	min 95 mm max 145 mm		min 15 mm max 22 mm	min 67 / max 69 cm
<b>1x</b>	<b>g</b>	min 95 mm max 145 mm		min 15 mm max 22 mm	min 54 / max 59 cm
<b>8x*/12x**</b>	<b>h</b>	** min 95 mm * max 145 mm		min 15 mm max 22 mm	min 52 / max 56 cm
<b>1x</b>	<b>i</b>	min 95 mm max 145 mm		min 15 mm max 22 mm	min 51 / max 53 cm
<b>3x</b>	<b>j</b>	min 95 mm max 145 mm		min 15 mm max 22 mm	min 47 / max 52 cm
<b>4x*/6x**</b>	<b>k</b>	** min 95 mm * max 145 mm		min 15 mm max 22 mm	48 cm
<b>2x</b>	<b>m</b>	min 95 mm max 145 mm		min 15 mm max 22 mm	40 cm

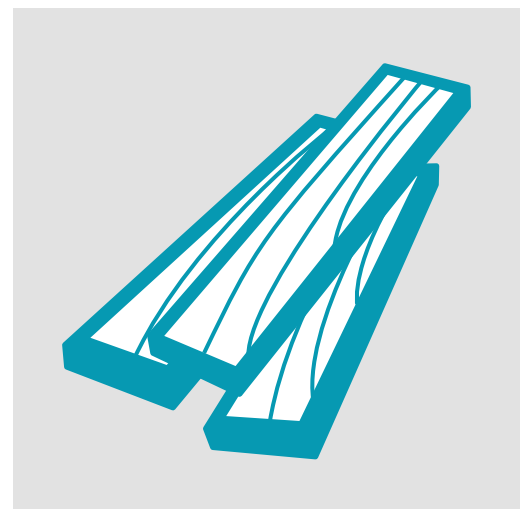

**4x** **A** min 68 mm | max 90 mm  200 cm 230 cm

min 68 mm  
max 90 mm

**3x** **B** min 68 mm | max 90 mm  130 cm

min 68 mm  
max 90 mm

**1x** **C** min 68 mm | max 90 mm  30 cm

min 68 mm  
max 90 mm

**2x** **D** min 68 mm | max 90 mm  130 cm

min 32 mm  
max 50 mm

**4x** **E** min 68 mm | max 90 mm  84 cm 70°

min 32 mm  
max 50 mm

**10x** **F** min 68 mm | max 90 mm  68,5 cm

min 32 mm  
max 50 mm

**2x** **G** min 68 mm | max 90 mm  65 cm 70°

min 32 mm  
max 50 mm

**2x** **H** min 68 mm | max 90 mm  min 56 / max 58 cm 70°

min 32 mm  
max 50 mm

**6x** **I** min 44 mm | max 45 mm  130 cm

min 44 mm  
max 45 mm

**2x** **J** min 44 mm | max 45 mm  min 91,5 / max 105,5 cm

min 44 mm  
max 45 mm

**1x** **K** min 44 mm | max 45 mm  65 cm

min 44 mm  
max 45 mm

**3x** **L** min 44 mm | max 45 mm  53 cm

min 44 mm  
max 45 mm

**2x** **M** min 44 mm | max 45 mm  51 cm

min 44 mm  
max 45 mm

**2x** **N** min 44 mm | max 45 mm  min 27 / max 43 cm

min 44 mm  
max 45 mm

**2x** **O** min 44 mm | max 45 mm  41 cm

min 44 mm  
max 45 mm

**6x\*/9x\*\*** **P** min 95 mm | max 145 mm  min 137 / max 139 cm

min 15 mm  
max 22 mm

**16x\*/22x\*\*** **Q** \*\* min 95 mm | \* max 145 mm  130 cm

min 15 mm  
max 22 mm

**2x** **R** min 95 mm | max 145 mm  min 116 / max 120 cm

min 15 mm  
max 22 mm

**10x\*/14x\*\*** **S** \*\* min 95 mm | \* max 145 mm  82 cm

min 15 mm  
max 22 mm

**8x\*/9x\*\*** **T** \*\* min 95 mm | \* max 145 mm  68,5 cm

min 15 mm  
max 22 mm

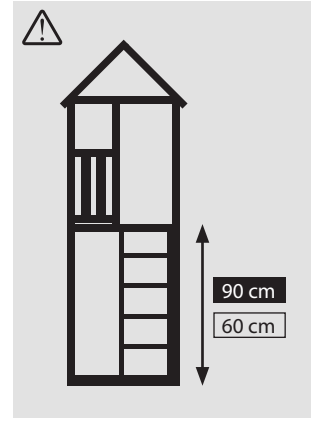

**8x\*/9x\*\*** **U** \*\* min 95 mm | \* max 145 mm  min 52,5 / max 55 cm

min 15 mm  
max 22 mm

**10x\*/15x\*\*** **V** \*\* min 95 mm | \* max 145 mm  min 50,5 / max 55 cm

min 15 mm  
max 22 mm

**22x\*/32x\*\*** **W** \*\* min 95 mm | \* max 145 mm  43 cm

min 15 mm  
max 22 mm









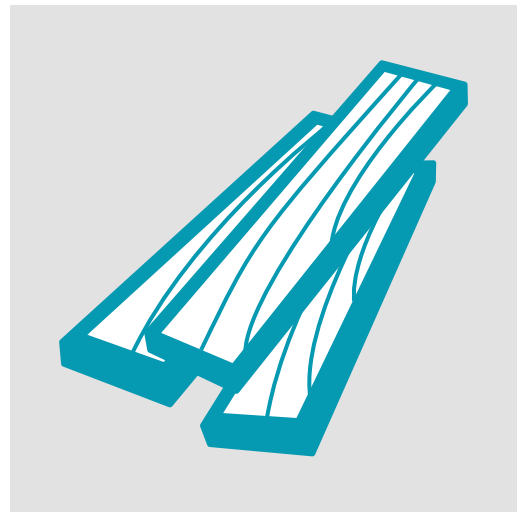



**7x\*/9x\*\*** **X** \*\* min 95 mm | \* max 145 mm  41 cm

min 15 mm  
max 22 mm

**2x** **Y** min 95 mm | max 145 mm  30 cm 55° 55°

min 15 mm  
max 22 mm



- 3x** **A** min 68 mm | max 90 mm  240 cm  
min 68 mm | max 90 mm
- 4x** **B** min 68 mm | max 90 mm  221 cm  
min 68 mm | max 90 mm
- 2x** **C** min 68 mm | max 90 mm  190 cm  
min 68 mm | max 90 mm
- 2x** **D** min 68 mm | max 90 mm  150 cm  
min 68 mm | max 90 mm
- 2x** **E** min 68 mm | max 90 mm  min 212 / max 214 cm  
min 32 mm | max 50 mm
- 8x** **F** min 68 mm | max 90 mm  min 199 / max 210 cm  
min 32 mm | max 50 mm
- 2x** **G** min 68 mm | max 90 mm  min 138,5 / max 143 cm  
min 32 mm | max 50 mm
- 2x** **H** min 68 mm | max 90 mm  min 67 / max 76 cm  
min 32 mm | max 50 mm
- 2x** **I** min 95 mm | max 145 mm  min 138,5 / max 143 cm  
min 15 mm | max 22 mm
- 20x\*/28x\*\*** **J** \*\* min 95 mm | \* max 145 mm  80 cm  
min 15 mm | max 22 mm
- 1x** **K** min 95 mm | max 145 mm  min 67 / max 76 cm  
min 15 mm | max 22 mm
- 15x\*/22x\*\*** **L** \*\* min 95 mm | \* max 145 mm  min 62 / max 66,5 cm  
min 15 mm | max 22 mm
- 10x\*/15x\*\*** **M** \*\* min 95 mm | \* max 145 mm  min 53,5 / max 58 cm  
min 15 mm | max 22 mm

