













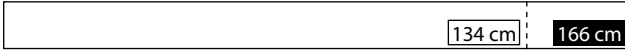



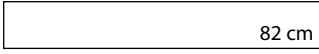

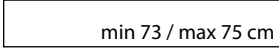

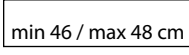

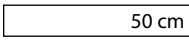





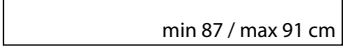



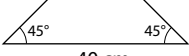
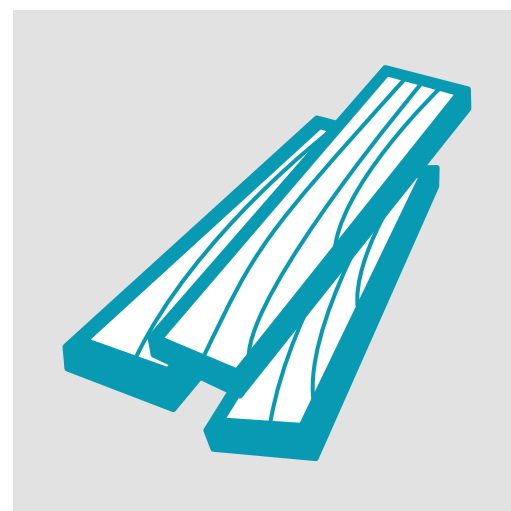
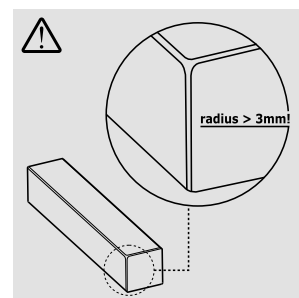
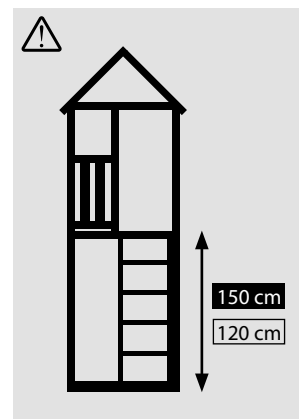











- 4x** **A** min 68 mm | max 90 mm  
min 68 mm | max 90 mm
- 2x** **B** min 68 mm | max 90 mm  
min 68 mm | max 90 mm
- 2x** **C** min 68 mm | max 90 mm  
min 32 mm | max 50 mm
- 9x** **D** min 68 mm | max 90 mm  
min 32 mm | max 50 mm
- 2x** **E** min 68 mm | max 90 mm  
min 32 mm | max 50 mm
- 2x** **F** min 68 mm | max 90 mm  
min 32 mm | max 50 mm
- 4x** **G** min 68 mm | max 90 mm  
min 32 mm | max 50 mm
- 3x 4x** **H** min 44 mm | max 45 mm  
min 44 mm | max 45 mm
- 12x*/18x**** **I** ** min 95 mm | * max 145 mm  
min 15 mm | max 22 mm
- 6x** **J** min 95 mm | max 145 mm  
min 15 mm | max 22 mm
- 8x*/12x**** **K** ** min 95 mm | * max 145 mm  
min 15 mm | max 22 mm
- 12x*/16x**** **L** ** min 95 mm | * max 145 mm  
min 15 mm | max 22 mm
- 2x** **M** min 95 mm | max 145 mm  
min 15 mm | max 22 mm



5x	A	min 68 mm max 90 mm		270 cm
		min 68 mm max 90 mm		
4x	B	min 68 mm max 90 mm		192 cm
		min 68 mm max 90 mm		
2x	C	min 68 mm max 90 mm		127 cm
		min 68 mm max 90 mm		
1x	D	min 68 mm max 90 mm		77 cm
		min 68 mm max 90 mm		
1x	E	min 68 mm max 90 mm		190 cm
		min 32 mm max 50 mm		
2x	F	min 68 mm max 90 mm		166 cm
		min 32 mm max 50 mm		
2x	G	min 68 mm max 90 mm		130 cm
		min 32 mm max 50 mm		
2x	H	min 68 mm max 90 mm		min 128 / max 130 cm
		min 32 mm max 50 mm		
6x	I	min 68 mm max 90 mm		120 cm
		min 32 mm max 50 mm		
2x	J	min 68 mm max 90 mm		95 cm
		min 32 mm max 50 mm		
2x	K	min 68 mm max 90 mm		min 86 / max 88 cm
		min 32 mm max 50 mm		
4x	L	min 68 mm max 90 mm		80 cm
		min 32 mm max 50 mm		
1x	M	min 68 mm max 90 mm		71 cm
		min 32 mm max 50 mm		
4x	N	min 68 mm max 90 mm		69 cm
		min 32 mm max 50 mm		
1x	O	min 68 mm max 90 mm		min 67 / max 69 cm
		min 32 mm max 50 mm		
1x	P	min 68 mm max 90 mm		63 cm
		min 32 mm max 50 mm		
4x	Q	min 68 mm max 90 mm		min 61 / max 63 cm
		min 32 mm max 50 mm		

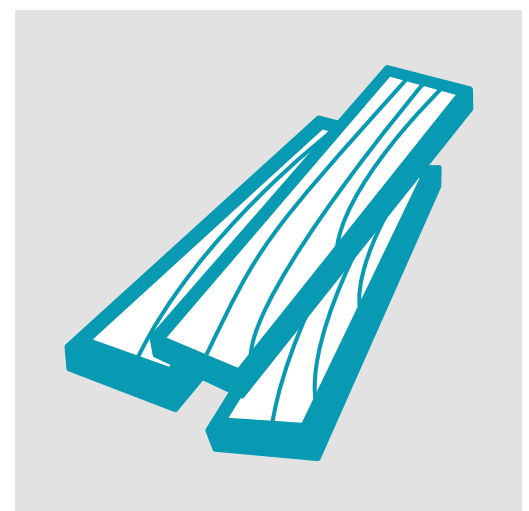
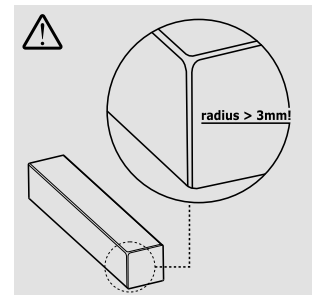

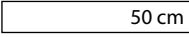

4x **R** min 44 mm | max 45 mm  

min 44 mm
max 45 mm

2x **S** min 95 mm | max 145 mm  

min 15 mm
max 22 mm

14x*/20x** **T** ** min 95 mm | * max 145 mm  

min 15 mm
max 22 mm

6x **U** min 95 mm | max 145 mm  

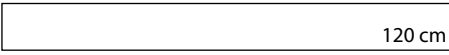

min 15 mm
max 22 mm

4x **V** min 95 mm | max 145 mm  

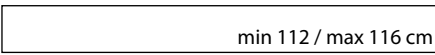

min 15 mm
max 22 mm

8x*/12x** **W** ** min 95 mm | * max 145 mm  

min 15 mm
max 22 mm

17x*/21x** **X** ** min 95 mm | * max 145 mm  

min 15 mm
max 22 mm

17x*/26x** **Y** ** min 95 mm | * max 145 mm  

min 15 mm
max 22 mm

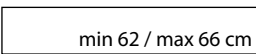
15x*/22x** **Z** ** min 95 mm | * max 145 mm  

min 15 mm
max 22 mm

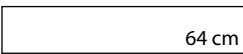
1x*/2x** **1** ** min 95 mm | * max 145 mm  

min 15 mm
max 22 mm

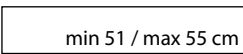
1x **2** min 95 mm | max 145 mm  

min 15 mm
max 22 mm

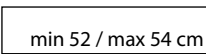



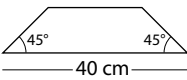



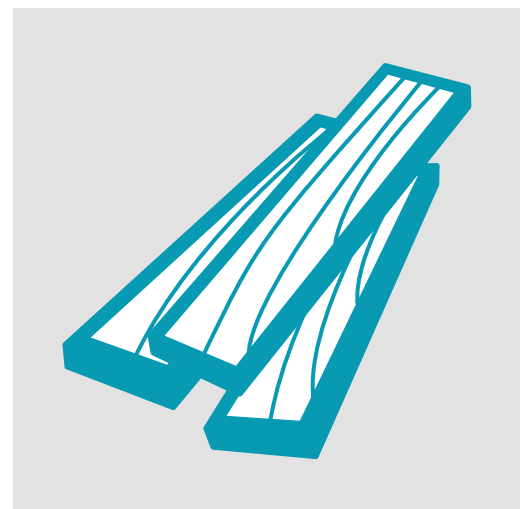
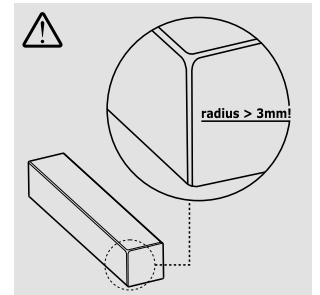

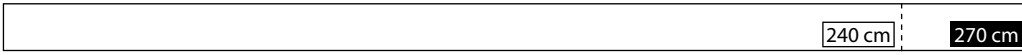





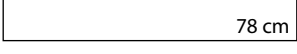

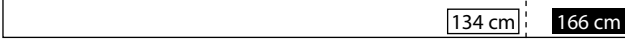



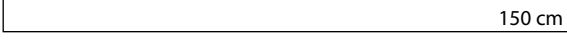

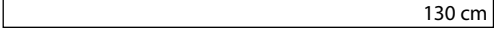

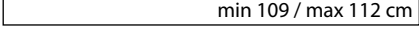

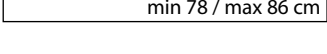

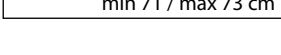

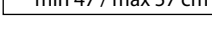

1x **3** min 95 mm | max 145 mm  

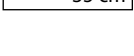
min 15 mm
max 22 mm

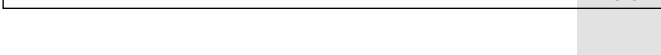
2x **4** min 95 mm | max 145 mm  

min 15 mm
max 22 mm



- 2x** **A** min 68 mm | max 90 mm   240 cm | 270 cm
min 68 mm | max 90 mm
- 2x** **B** min 68 mm | max 90 mm   191 cm | 221 cm
min 68 mm | max 90 mm
- 1x** **C** min 68 mm | max 90 mm   127 cm
min 68 mm | max 90 mm
- 1x** **D** min 68 mm | max 90 mm   78 cm
min 68 mm | max 90 mm
- 2x** **E** min 68 mm | max 90 mm   134 cm | 166 cm
min 32 mm | max 50 mm
- 2x** **F** min 68 mm | max 90 mm   160 cm
min 32 mm | max 50 mm
- 7x** **G** min 68 mm | max 90 mm   150 cm
min 32 mm | max 50 mm
- 6x** **H** min 68 mm | max 90 mm   130 cm
min 32 mm | max 50 mm
- 1x** **I** min 68 mm | max 90 mm   min 109 / max 112 cm
min 32 mm | max 50 mm
- 2x** **J** min 68 mm | max 90 mm   min 78 / max 86 cm
min 32 mm | max 50 mm
- 2x** **K** min 68 mm | max 90 mm   min 71 / max 73 cm
min 32 mm | max 50 mm
- 2x** **L** min 44 mm | max 45 mm   min 47 / max 57 cm
min 44 mm | max 45 mm
- 3x** **4x** **M** min 44 mm | max 45 mm   50 cm
min 44 mm | max 45 mm
- 2x** **N** min 44 mm | max 45 mm   35 cm
min 44 mm | max 45 mm
- 11x*/17x**** **O** ** min 95 mm | * max 145 mm   175 cm
min 15 mm | max 22 mm
- 8x*/10x**** **P** ** min 95 mm | * max 145 mm   150 cm
min 15 mm | max 22 mm
- 10x*/14x**** **Q** ** min 95 mm | * max 145 mm   min 132 / max 136 cm
min 15 mm | max 22 mm
- 4x** **R** min 95 mm | max 145 mm   130 cm
min 15 mm | max 22 mm

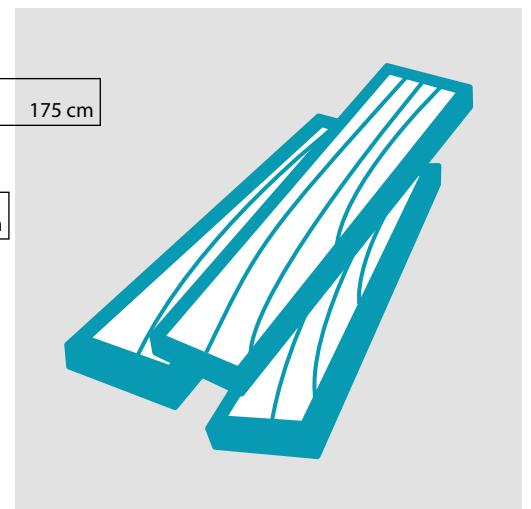
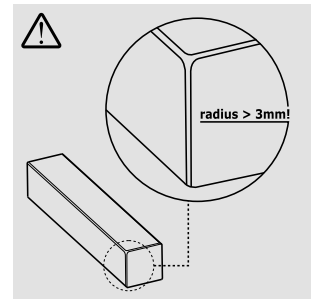
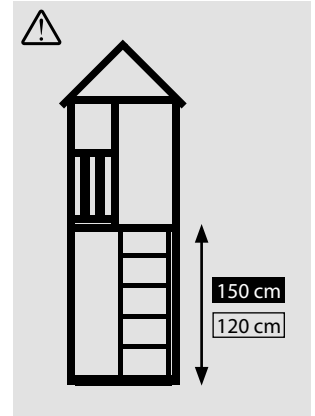

5x*/8x** **S** ** min 95 mm
* max 145 mm



118 cm

min 15 mm
max 22 mm

3x*/4x** **T** ** min 95 mm
* max 145 mm



85 cm

min 15 mm
max 22 mm

4x*/6x** **U** ** min 95 mm
* max 145 mm



69 cm

min 15 mm
max 22 mm

3x*/4x** **V** ** min 95 mm
* max 145 mm











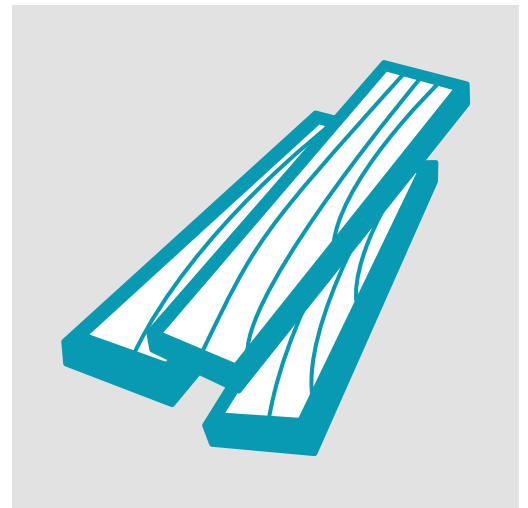





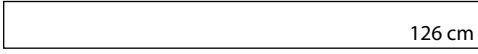



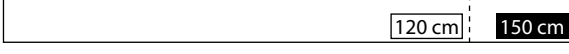

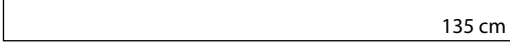

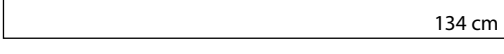

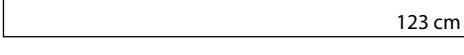



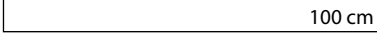



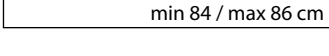

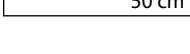

30 cm

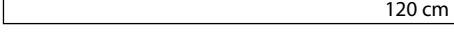
min 15 mm
max 22 mm

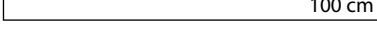

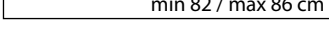
α

		α			
		95 mm	120 mm	145 mm	
2x	1	α	122 cm	122 cm	122 cm
		min 15 mm max 22 mm			
2x	2	α	126 cm	125 cm	128 cm
		min 15 mm max 22 mm			
2x	3	α	130 cm	130 cm	133 cm
		min 15 mm max 22 mm			
2x	4	α	134 cm	135 cm	139 cm
		min 15 mm max 22 mm			
2x	5	α	137 cm	140 cm	145 cm
		min 15 mm max 22 mm			
2x	6	α	141 cm	145 cm	-
		min 15 mm max 22 mm			
2x	7	α	145 cm	-	-
		min 15 mm max 22 mm			

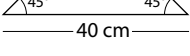

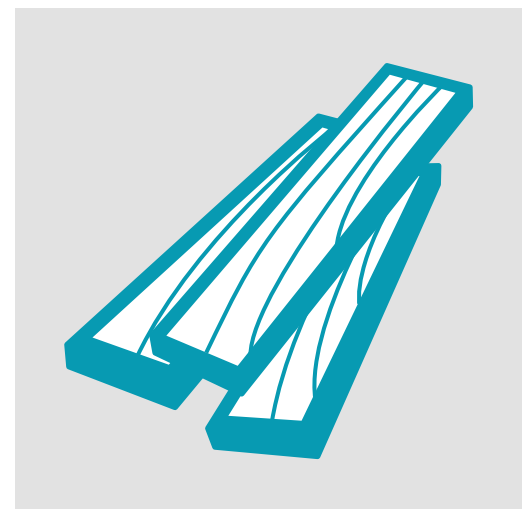
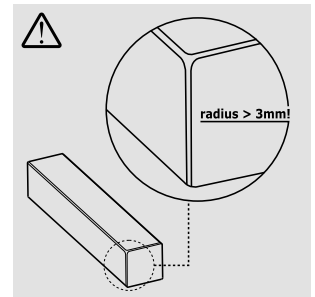
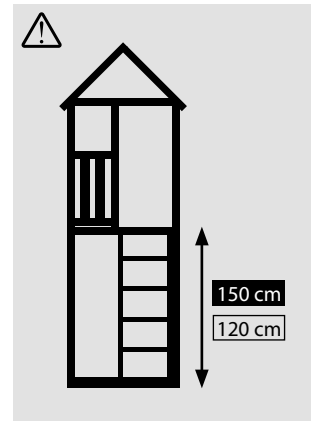

- 4x** **A** min 68 mm | max 90 mm   240 cm | 270 cm
min 68 mm | max 90 mm
- 1x** **B** min 68 mm | max 90 mm   126 cm
min 68 mm | max 90 mm
- 2x** **C** min 68 mm | max 90 mm   134 cm | 166 cm
min 32 mm | max 50 mm
- 1x** **D** min 68 mm | max 90 mm   120 cm | 150 cm
min 32 mm | max 50 mm
- 3x** **E** min 68 mm | max 90 mm   135 cm
min 32 mm | max 50 mm
- 1x** **F** min 68 mm | max 90 mm   134 cm
min 32 mm | max 50 mm
- 1x** **G** min 68 mm | max 90 mm   123 cm
min 32 mm | max 50 mm
- 2x** **H** min 68 mm | max 90 mm   115 cm
min 32 mm | max 50 mm
- 3x** **I** min 68 mm | max 90 mm   100 cm
min 32 mm | max 50 mm
- 2x** **J** min 68 mm | max 90 mm   93 cm
min 32 mm | max 50 mm
- 2x** **K** min 68 mm | max 90 mm   min 84 / max 86 cm
min 32 mm | max 50 mm
- 3x 4x** **L** min 44 mm | max 45 mm   50 cm
min 44 mm | max 45 mm
- 2x** **M** min 95 mm | max 145 mm   155 cm | 160 cm
min 15 mm | max 22 mm
- 14x*/20x**** **N** ** min 95 mm | * max 145 mm   120 cm
min 15 mm | max 22 mm
- 13x*/18x**** **O** ** min 95 mm | * max 145 mm   100 cm
min 15 mm | max 22 mm
- 10x*/15x**** **P** ** min 95 mm | * max 145 mm   min 82 / max 86 cm
min 15 mm | max 22 mm
- 10x*/13x**** **Q** ** min 95 mm | * max 145 mm   69 cm
min 15 mm | max 22 mm
- 2x** **R** min 95 mm | max 145 mm   40 cm
min 15 mm | max 22 mm



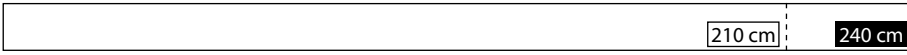

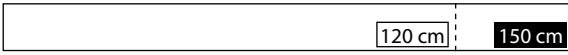
- 2x** **A** min 68 mm max 90 mm  

min 68 mm max 90 mm
- 2x** **B** min 68 mm max 90 mm  

min 68 mm max 90 mm
- 2x** **C** min 68 mm max 90 mm  

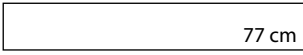
min 68 mm max 90 mm
- 1x** **D** min 68 mm max 90 mm  

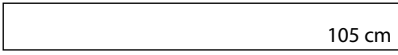

min 68 mm max 90 mm
- 1x** **E** min 68 mm max 90 mm  

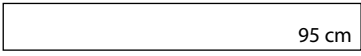
min 68 mm max 90 mm
- 7x** **F** min 68 mm max 90 mm  

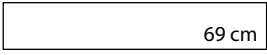

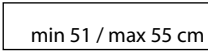
min 32 mm max 50 mm
- 6x** **G** min 68 mm max 90 mm  

min 32 mm max 50 mm
- 5x** **H** min 68 mm max 90 mm  

min 32 mm max 50 mm
- 3x** **I** min 68 mm max 90 mm  

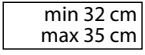
min 32 mm max 50 mm
- 1x** **J** min 68 mm max 90 mm  

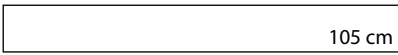

min 32 mm max 50 mm
- 1x** **K** min 68 mm max 90 mm  

min 32 mm max 50 mm
- 8x*/11x**** **L** ** min 95 mm * max 145 mm  

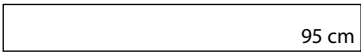
min 15 mm max 22 mm
- 4x** **M** min 95 mm max 145 mm  

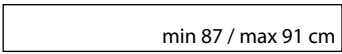
min 15 mm max 22 mm
- 2x** **N** min 95 mm max 145 mm  





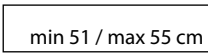



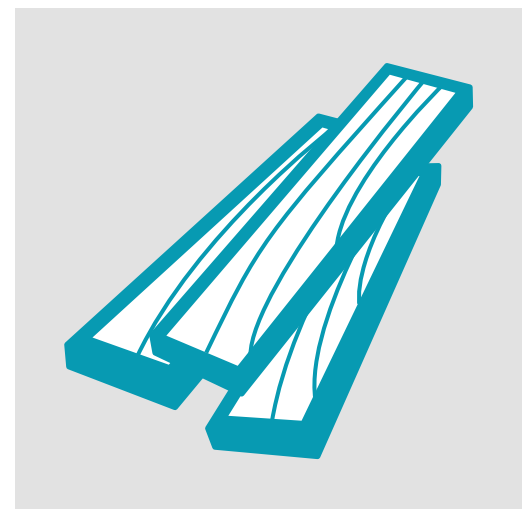
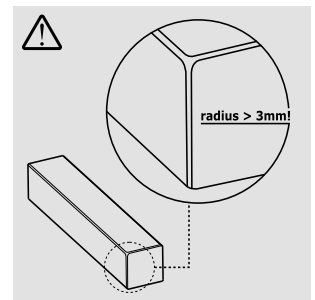
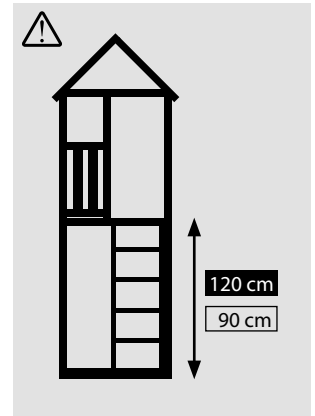



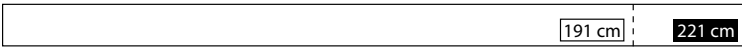

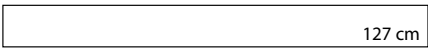

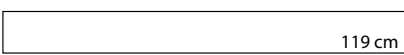

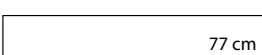

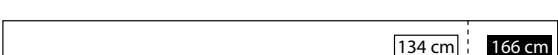

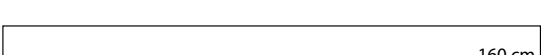

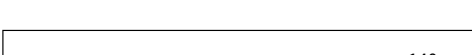

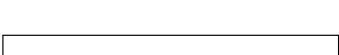

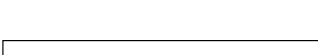







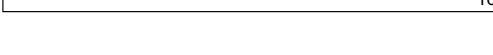

min 15 mm max 22 mm
- 7x*/11x**** **O** ** min 95 mm * max 145 mm  

min 15 mm max 22 mm
- 16x*/19x**** **P** ** min 95 mm * max 145 mm  

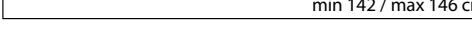



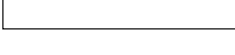



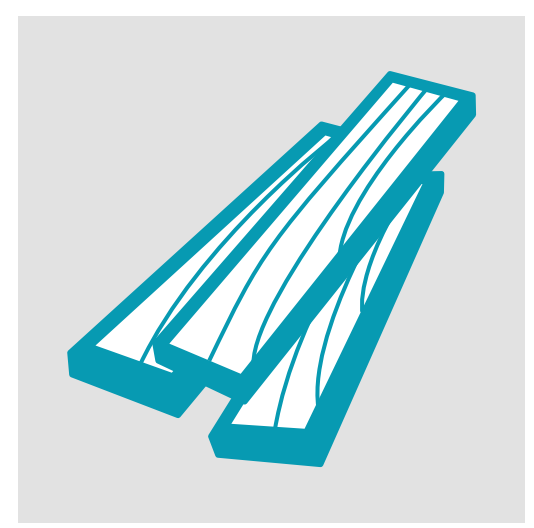
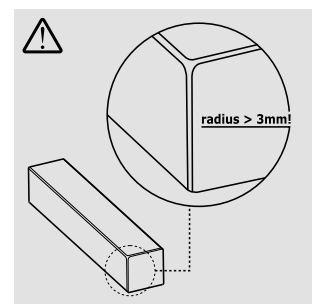
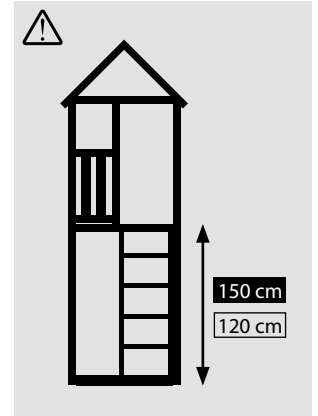









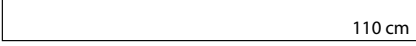

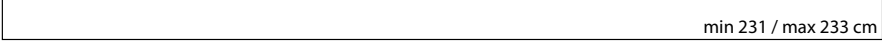

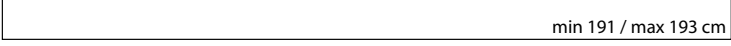



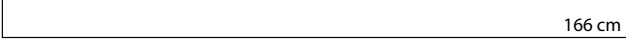

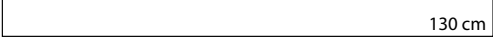

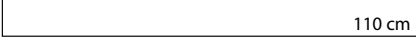



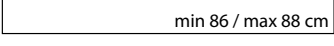

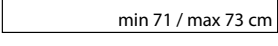
min 15 mm max 22 mm
- 11x*/17x**** **Q** ** min 95 mm * max 145 mm  

min 15 mm max 22 mm

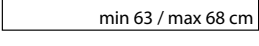

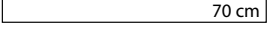

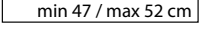



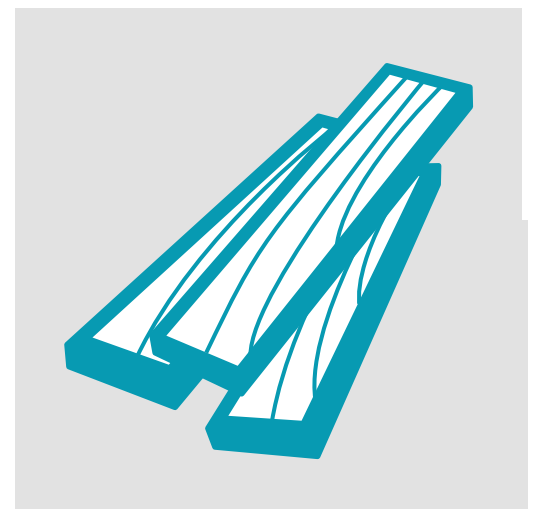











- 2x** **A** min 68 mm | max 90 mm  
min 68 mm
max 90 mm
- 3x** **B** min 68 mm | max 90 mm  
min 68 mm
max 90 mm
- 1x** **C** min 68 mm | max 90 mm  
min 68 mm
max 90 mm
- 2x** **D** min 68 mm | max 90 mm  
min 68 mm
max 90 mm
- 1x** **E** min 68 mm | max 90 mm  
min 68 mm
max 90 mm
- 2x** **F** min 68 mm | max 90 mm  
min 32 mm
max 50 mm
- 4x** **G** min 68 mm | max 90 mm  
min 32 mm
max 50 mm
- 6x** **H** min 68 mm | max 90 mm  
min 32 mm
max 50 mm
- 2x** **I** min 68 mm | max 90 mm  
min 32 mm
max 50 mm
- 2x** **J** min 68 mm | max 90 mm  
min 32 mm
max 50 mm
- 2x** **K** min 68 mm | max 90 mm  
min 32 mm
max 50 mm
- 4x** **L** min 68 mm | max 90 mm  
min 32 mm
max 50 mm
- 3x 4x** **M** min 44 mm | max 45 mm  
min 44 mm
max 45 mm
- 3x 4x** **N** min 44 mm | max 45 mm  
min 44 mm
max 45 mm
- 6x** **O** min 95 mm | max 145 mm  
min 15 mm
max 22 mm
- 10x*/15x**** **P** ** min 95 mm | * max 145 mm  
min 15 mm
max 22 mm
- 4x** **Q** min 95 mm | max 145 mm  
min 15 mm
max 22 mm
- 16x*/24x**** **R** ** min 95 mm | * max 145 mm  
min 15 mm
max 22 mm
- 15x*/20x**** **S** ** min 95 mm | * max 145 mm  
min 15 mm
max 22 mm
- 2x** **T** min 95 mm | max 145 mm  
min 15 mm
max 22 mm



7x	A	min 68 mm max 90 mm			270 cm
				min 68 mm max 90 mm	
1x	B	min 68 mm max 90 mm			240 cm
				min 68 mm max 90 mm	
1x	C	min 68 mm max 90 mm			221 cm
				min 68 mm max 90 mm	
2x	D	min 68 mm max 90 mm			127 cm
				min 68 mm max 90 mm	
2x	E	min 68 mm max 90 mm			110 cm
				min 68 mm max 90 mm	
1x	F	min 68 mm max 90 mm			min 231 / max 233 cm
				min 32 mm max 50 mm	
3x	G	min 68 mm max 90 mm			min 191 / max 193 cm
				min 32 mm max 50 mm	
2x	H	min 68 mm max 90 mm			min 172 / max 176 cm
				min 32 mm max 50 mm	
2x	I	min 68 mm max 90 mm			166 cm
				min 32 mm max 50 mm	
11x	J	min 68 mm max 90 mm			130 cm
				min 32 mm max 50 mm	
9x	K	min 68 mm max 90 mm			110 cm
				min 32 mm max 50 mm	
2x	L	min 68 mm max 90 mm			95 cm
				min 32 mm max 50 mm	
2x	M	min 68 mm max 90 mm			min 86 / max 88 cm
				min 32 mm max 50 mm	
2x	N	min 68 mm max 90 mm			min 71 / max 73 cm
				min 32 mm max 50 mm	
2x	O	min 68 mm max 90 mm			70 cm
				min 32 mm max 50 mm	
1x	P	min 68 mm max 90 mm			min 63 / max 68 cm
				min 32 mm max 50 mm	
5x	Q	min 44 mm max 45 mm			70 cm
				min 44 mm max 45 mm	
2x	R	min 44 mm max 45 mm			min 47 / max 52 cm
				min 44 mm max 45 mm	
4x	S	min 44 mm max 45 mm			50 cm
				min 44 mm max 45 mm	

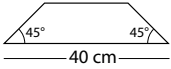

1x	T	min 44 mm max 45 mm		7 cm
		min 44 mm max 45 mm		
1x	U	min 95 mm max 145 mm		min 231 / max 233 cm
		min 15 mm max 22 mm		
2x	V	min 95 mm max 145 mm		min 191 / max 193 cm
		min 15 mm max 22 mm		
22x*/32x**	W	** min 95 mm * max 145 mm		143 cm
		min 15 mm max 22 mm		
13x*/17x**	X	** min 95 mm * max 145 mm		130 cm
		min 15 mm max 22 mm		
9x*/13x**	Y	** min 95 mm * max 145 mm		min 112 / max 116 cm
		min 15 mm max 22 mm		
20x*/27x**	Z	** min 95 mm * max 145 mm		110 cm
		min 15 mm max 22 mm		
4x*/6x**	a	** min 95 mm * max 145 mm		105 cm
		min 15 mm max 22 mm		
4x*/6x**	b	** min 95 mm * max 145 mm		98 cm
		min 15 mm max 22 mm		
21x*/29x**	c	** min 95 mm * max 145 mm		min 92 / max 96 cm
		min 15 mm max 22 mm		
16x*/22x**	d	** min 95 mm * max 145 mm		70 cm
		min 15 mm max 22 mm		
19x*/25x**	e	** min 95 mm * max 145 mm		69 cm
		min 15 mm max 22 mm		
2x	f	min 95 mm max 145 mm		min 67 / max 69 cm
		min 15 mm max 22 mm		
1x	g	min 95 mm max 145 mm		min 54 / max 59 cm
		min 15 mm max 22 mm		
8x*/12x**	h	** min 95 mm * max 145 mm		min 52 / max 56 cm
		min 15 mm max 22 mm		
1x	i	min 95 mm max 145 mm		min 51 / max 53 cm
		min 15 mm max 22 mm		
3x	j	min 95 mm max 145 mm		min 47 / max 52 cm
		min 15 mm max 22 mm		
4x*/6x**	k	** min 95 mm * max 145 mm		48 cm
		min 15 mm max 22 mm		
2x	m	min 95 mm max 145 mm		
		min 15 mm max 22 mm		

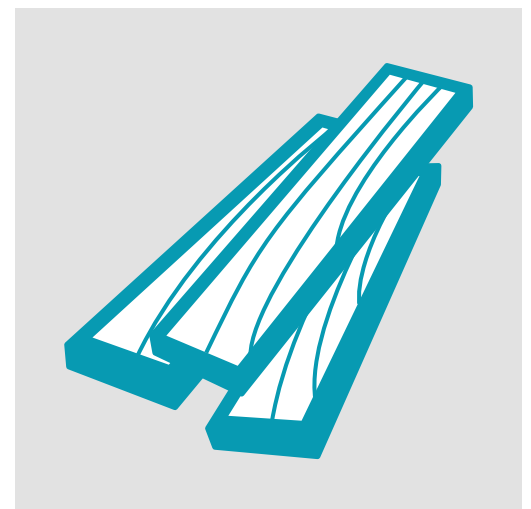

4x **A** min 68 mm | max 90 mm  200 cm 230 cm

min 68 mm
max 90 mm

3x **B** min 68 mm | max 90 mm  130 cm

min 68 mm
max 90 mm

1x **C** min 68 mm | max 90 mm  30 cm

min 68 mm
max 90 mm

2x **D** min 68 mm | max 90 mm  130 cm

min 32 mm
max 50 mm

4x **E** min 68 mm | max 90 mm  84 cm 70°

min 32 mm
max 50 mm

10x **F** min 68 mm | max 90 mm  68,5 cm

min 32 mm
max 50 mm

2x **G** min 68 mm | max 90 mm  65 cm 70°

min 32 mm
max 50 mm

2x **H** min 68 mm | max 90 mm  min 56 / max 58 cm 70°

min 32 mm
max 50 mm

6x **I** min 44 mm | max 45 mm  130 cm

min 44 mm
max 45 mm

2x **J** min 44 mm | max 45 mm  min 91,5 / max 105,5 cm

min 44 mm
max 45 mm

1x **K** min 44 mm | max 45 mm  65 cm

min 44 mm
max 45 mm

3x **L** min 44 mm | max 45 mm  53 cm

min 44 mm
max 45 mm

2x **M** min 44 mm | max 45 mm  51 cm

min 44 mm
max 45 mm

2x **N** min 44 mm | max 45 mm  min 27 / max 43 cm

min 44 mm
max 45 mm

2x **O** min 44 mm | max 45 mm  41 cm

min 44 mm
max 45 mm

6x*/9x** **P** min 95 mm | max 145 mm  min 137 / max 139 cm

min 15 mm
max 22 mm

16x*/22x** **Q** ** min 95 mm | * max 145 mm  130 cm

min 15 mm
max 22 mm

2x **R** min 95 mm | max 145 mm  min 116 / max 120 cm

min 15 mm
max 22 mm

10x*/14x** **S** ** min 95 mm | * max 145 mm  82 cm

min 15 mm
max 22 mm

8x*/9x** **T** ** min 95 mm | * max 145 mm  68,5 cm

min 15 mm
max 22 mm

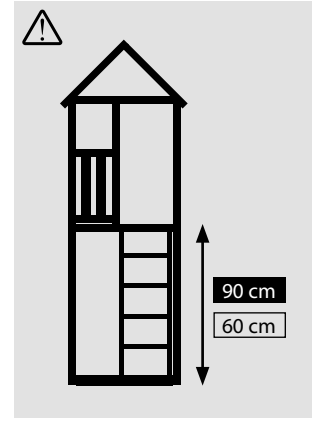

8x*/9x** **U** ** min 95 mm | * max 145 mm  min 52,5 / max 55 cm

min 15 mm
max 22 mm

10x*/15x** **V** ** min 95 mm | * max 145 mm  min 50,5 / max 55 cm

min 15 mm
max 22 mm

22x*/32x** **W** ** min 95 mm | * max 145 mm  43 cm

min 15 mm
max 22 mm

7x*/9x** **X** ** min 95 mm | * max 145 mm  41 cm

min 15 mm
max 22 mm









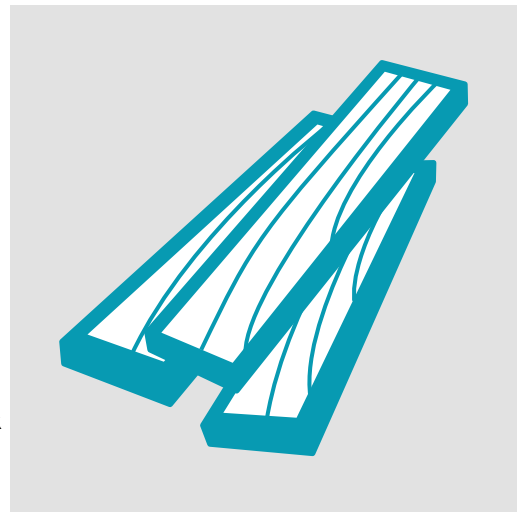



2x **Y** min 95 mm | max 145 mm  30 cm 55° 55°

min 15 mm
max 22 mm

1x **Z** min 95 mm | max 145 mm  7 cm

min 15 mm
max 22 mm



- 3x** **A** min 68 mm | max 90 mm  240 cm
min 68 mm | max 90 mm
- 4x** **B** min 68 mm | max 90 mm  221 cm
min 68 mm | max 90 mm
- 2x** **C** min 68 mm | max 90 mm  190 cm
min 68 mm | max 90 mm
- 2x** **D** min 68 mm | max 90 mm  150 cm
min 68 mm | max 90 mm
- 2x** **E** min 68 mm | max 90 mm  min 212 / max 214 cm
min 32 mm | max 50 mm
- 8x** **F** min 68 mm | max 90 mm  min 199 / max 210 cm
min 32 mm | max 50 mm
- 2x** **G** min 68 mm | max 90 mm  min 138,5 / max 143 cm
min 32 mm | max 50 mm
- 2x** **H** min 68 mm | max 90 mm  min 67 / max 76 cm
min 32 mm | max 50 mm
- 2x** **I** min 95 mm | max 145 mm  min 138,5 / max 143 cm
min 15 mm | max 22 mm
- 20x*/28x**** **J** ** min 95 mm | * max 145 mm  80 cm
min 15 mm | max 22 mm
- 1x** **K** min 95 mm | max 145 mm  min 67 / max 76 cm
min 15 mm | max 22 mm
- 15x*/22x**** **L** ** min 95 mm | * max 145 mm  min 62 / max 66,5 cm
min 15 mm | max 22 mm
- 10x*/15x**** **M** ** min 95 mm | * max 145 mm  min 53,5 / max 58 cm
min 15 mm | max 22 mm

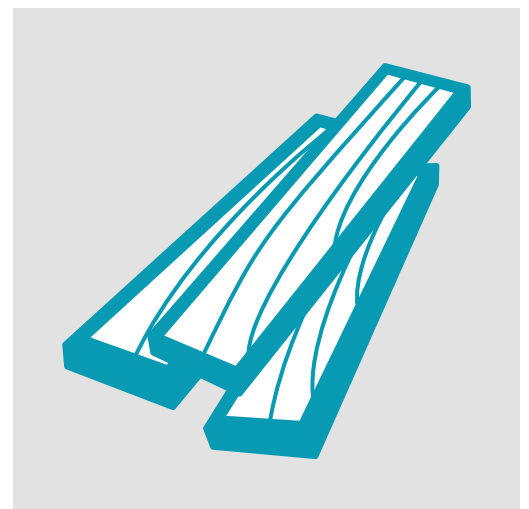

1x

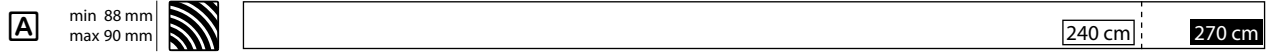

min 88 mm max 90 mm

4x

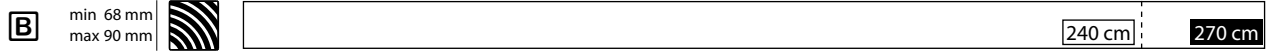

min 68 mm max 90 mm

2x

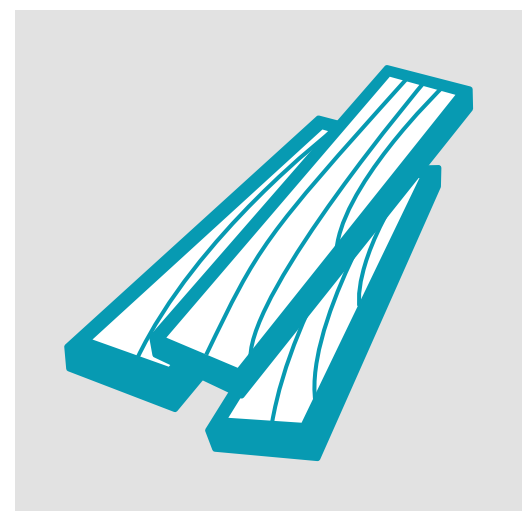
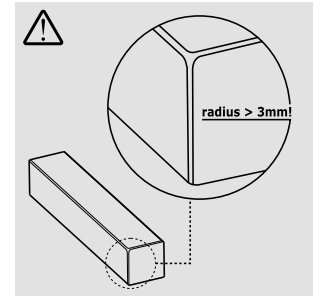
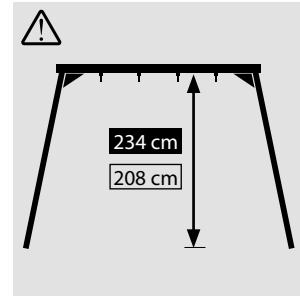
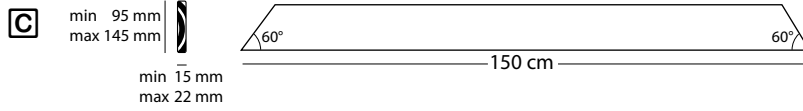



min 32 mm
max 50 mm

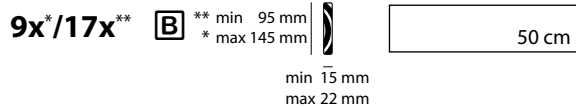

min 15 mm
max 22 mm

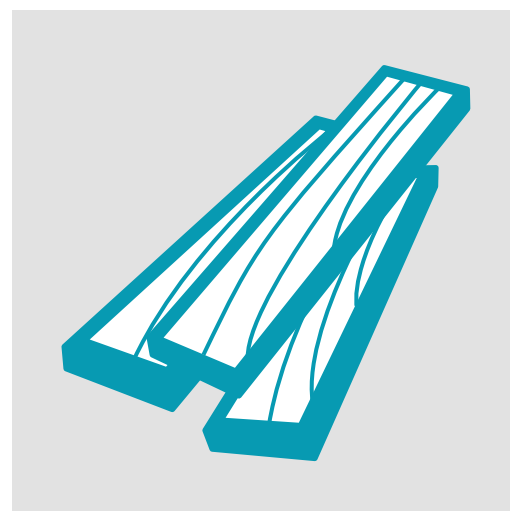
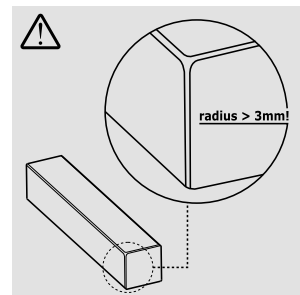
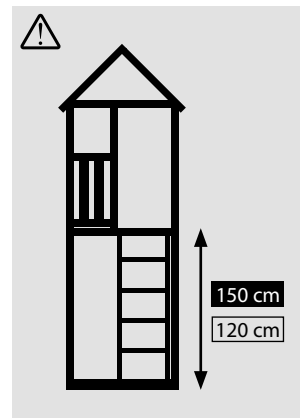

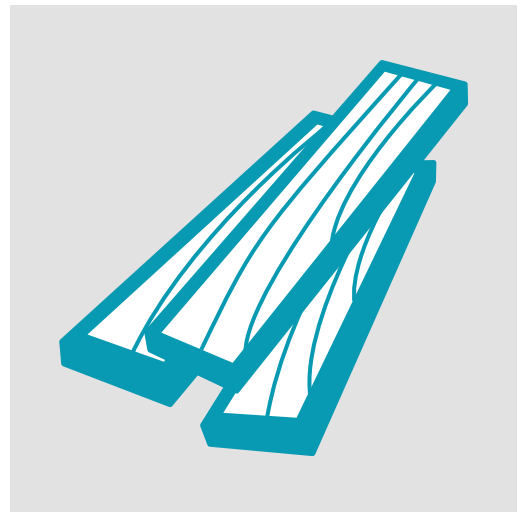
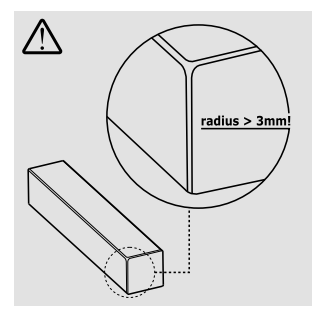
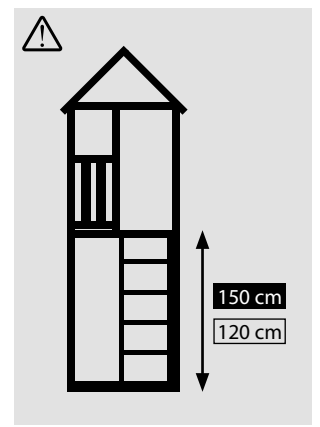
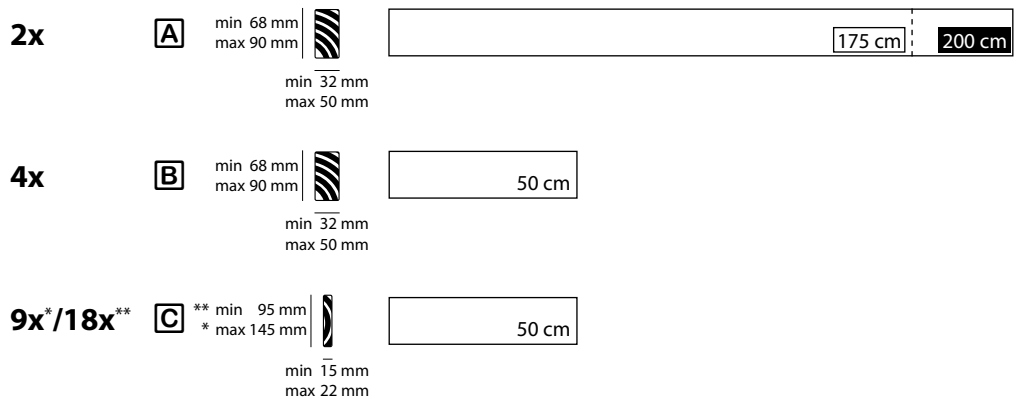

no wood required

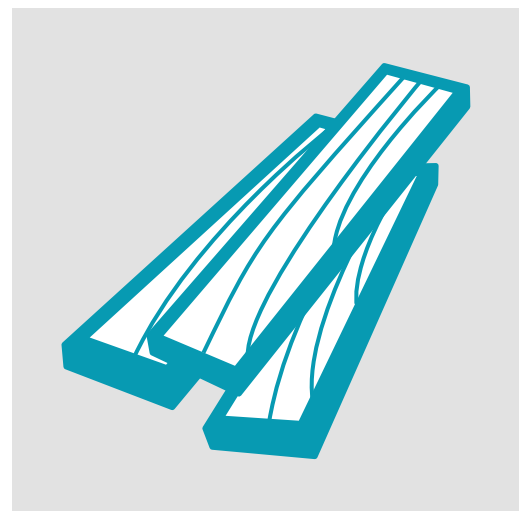

2x



2x

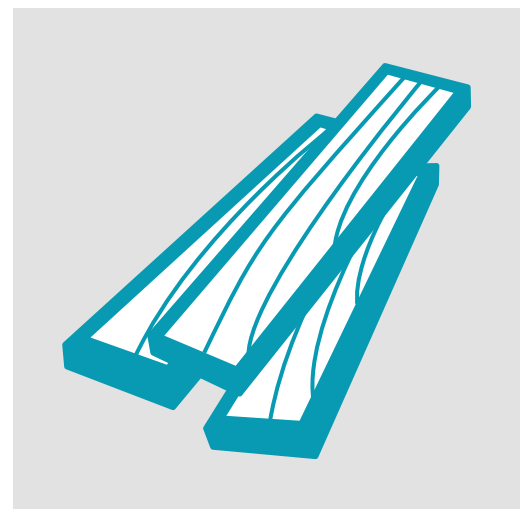
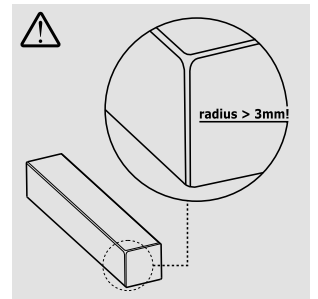
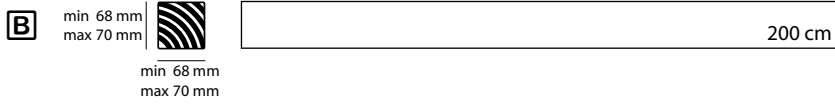

1x

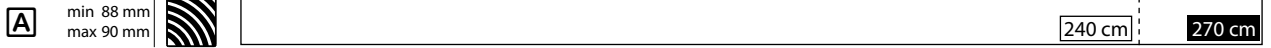

min 88 mm max 90 mm

2x

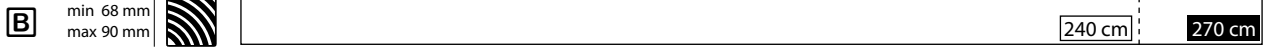

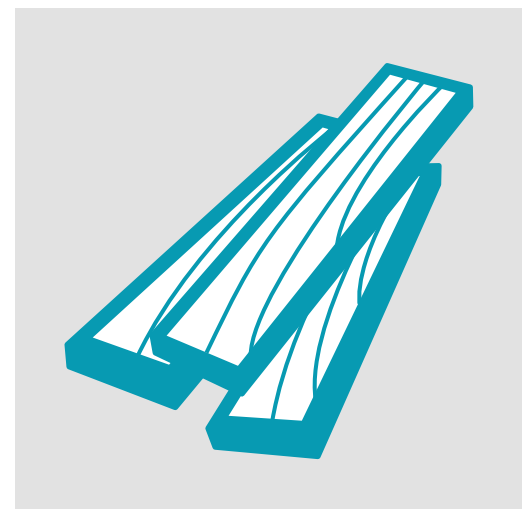
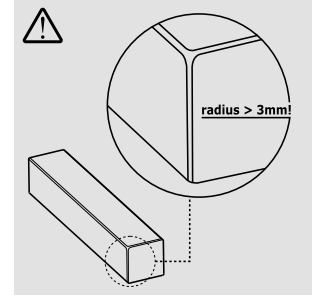
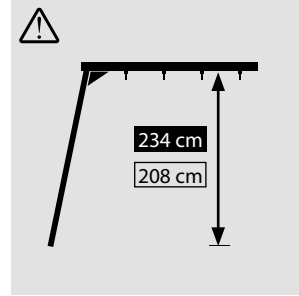

min 68 mm max 90 mm

1x





- 1x** **A** min 88 mm |  max 90 mm 240 cm 270 cm

min 88 mm
max 90 mm
- 2x** **B** min 68 mm |  max 90 mm 240 cm 270 cm

min 68 mm
max 90 mm
- 2x** **C** min 68 mm |  max 90 mm 210 cm 240 cm

min 68 mm
max 90 mm
- 1x** **D** min 68 mm |  max 90 mm 127 cm 157 cm

min 68 mm
max 90 mm
- 2x** **E** min 68 mm |  max 90 mm 125 cm

min 32 mm
max 50 mm
- 6x 7x** **F** min 68 mm |  max 90 mm 93 cm

min 32 mm
max 50 mm
- 1x** **G** min 68 mm |  max 90 mm min 75 / max 79 cm

min 32 mm
max 50 mm
- 1x** **H** min 68 mm |  max 90 mm 45 cm

min 32 mm
max 50 mm
- 10x*/15x****
12x*/18x** **I** ** min 95 mm |  * max 145 mm 93 cm

min 15 mm
max 22 mm
- 6x*/9x****
8x*/12x** **J** ** min 95 mm |  * max 145 mm min 75 / max 79 cm

min 15 mm
max 22 mm
- 1x** **K** min 95 mm |  max 145 mm 45°
-17 cm-

min 15 mm
max 22 mm
- 2x*/3x****
2x*/3x** **L** ** min 95 mm |  * max 145 mm min 117 / max 121cm

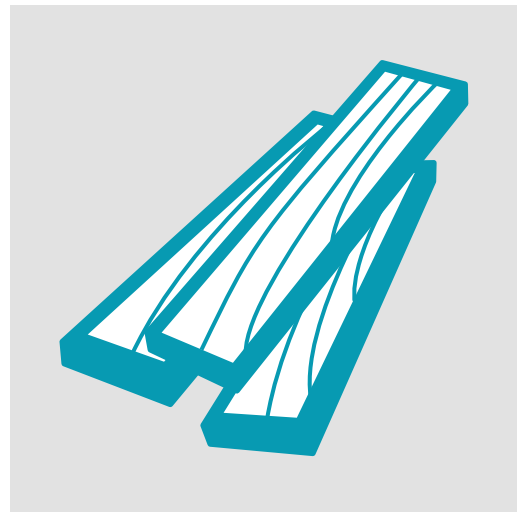
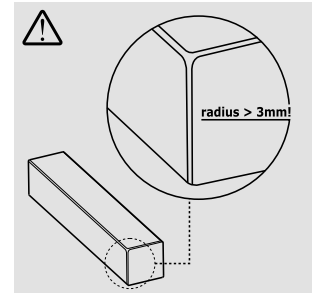
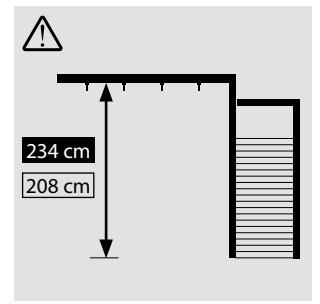

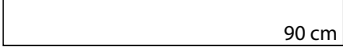

- 2x** **A** min 68 mm
max 90 mm   90 cm

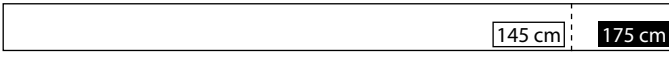
min 68 mm
max 90 mm

- 4x** **B** min 68 mm
max 90 mm   145 cm 175 cm

min 32 mm
max 50 mm

- 2x** **C** min 95 mm
max 145 mm   50 cm

min 15 mm
max 22 mm

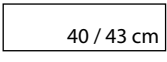
- 7x** **D** min 95 mm
max 145 mm   40 / 43 cm

min 15 mm
max 22 mm

