



Crossfit

008.001.009.001



blue rabbit

© 2025
Blue Rabbit 2.0 - Hemelrijken 12 - 2890 Puurs-Sint-Amands - Belgium.
Copyrighted material - Do not reproduce under penalty of law.

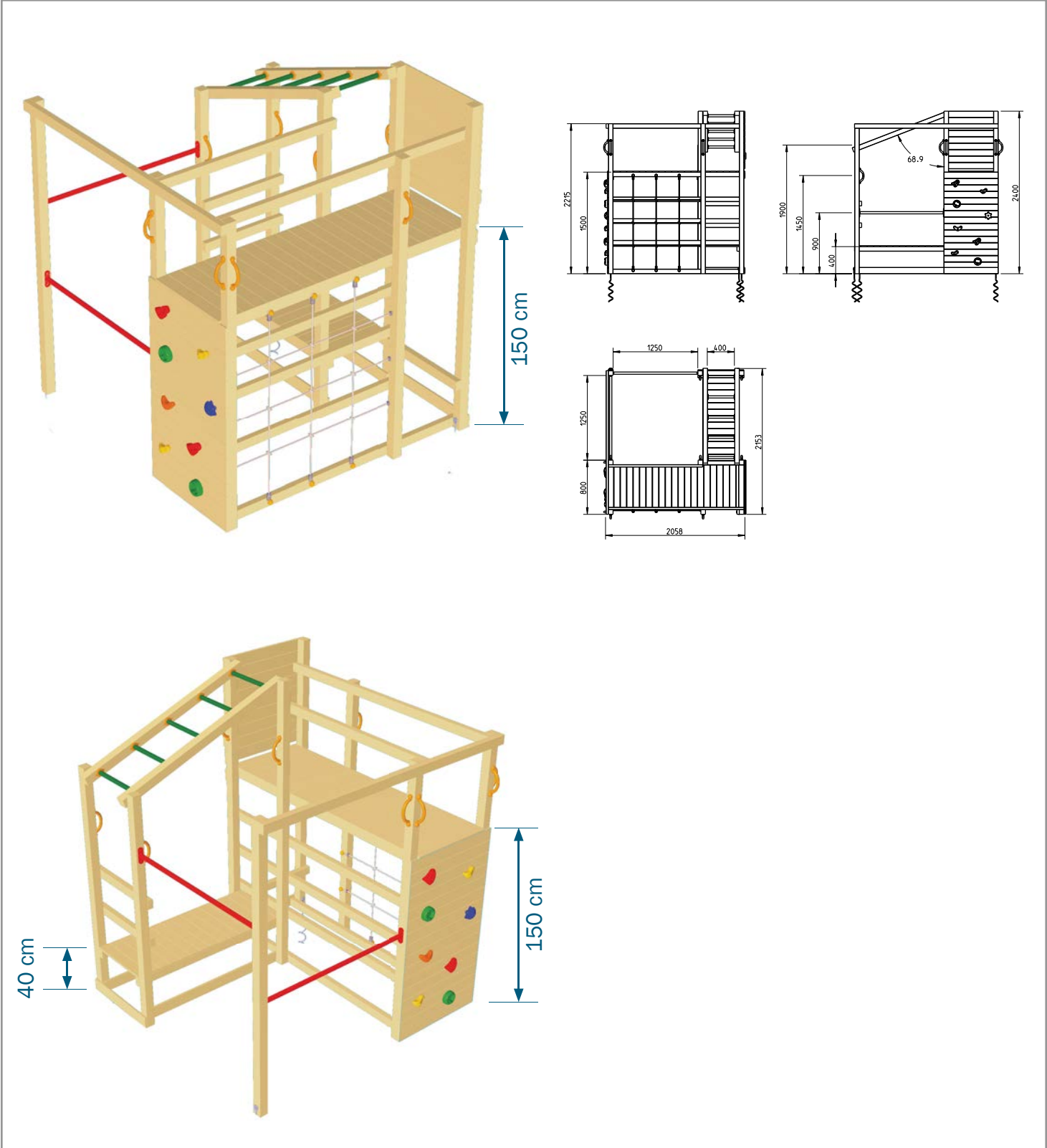

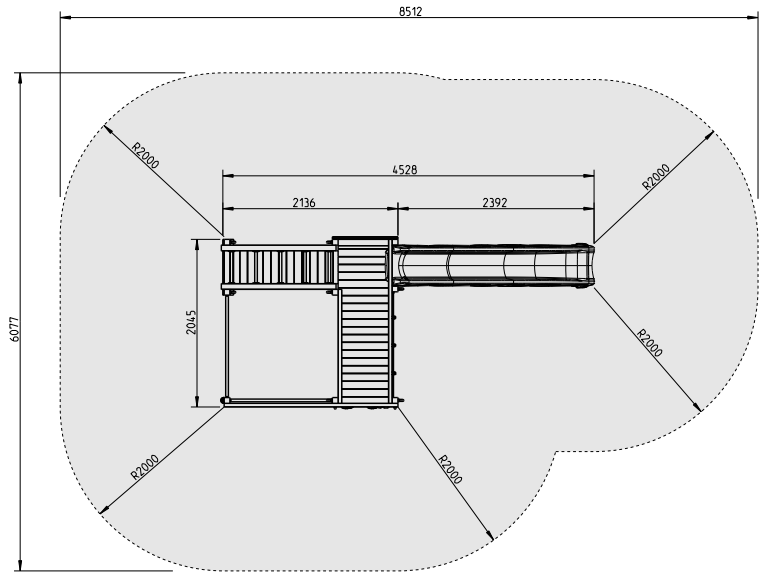
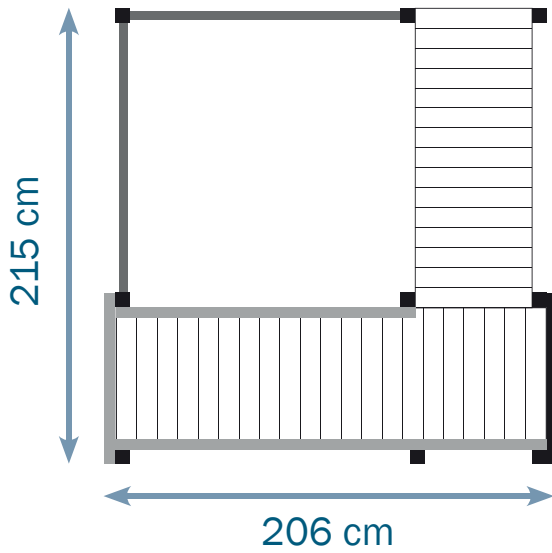

| | | | | |
|--|---|---|---|---|
| | | | @challenger 008.003.007.001 | |
| | | | @swing 008.003.005.001 | |
| Crossfit 008.001.009.001 | Ⓐ | Ⓐ | X | → |

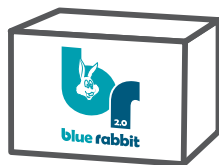

126 x 30 x 11 cm



13,5 kg

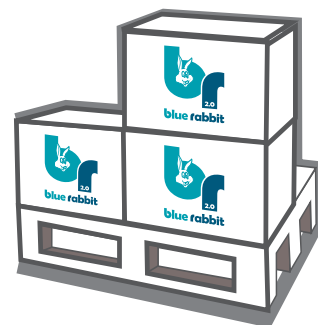











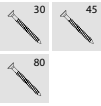





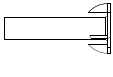

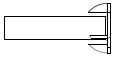
25

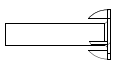









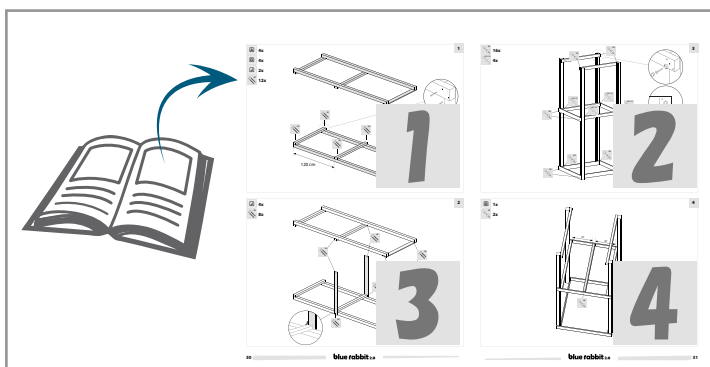
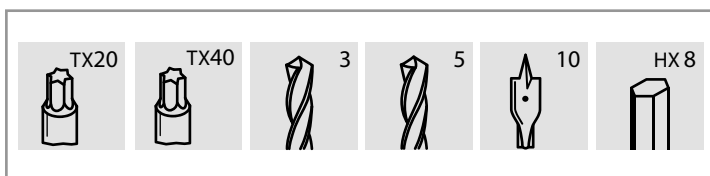





126 x 80 x 81 cm



363 kg

| | |
|---|---|
|  30 mm - 45 mm - 80 mm |  50 mm |
|  45 mm - 80 mm | 8x  25 mm |
|  50 mm - 80 mm | 8x  40 mm |
| 8x  70 mm |  60 mm |
| 4x  90 / 110 mm |  60 mm |
| 4x  130 / 170 mm |  60 mm |
| 3x  40 mm | 3x  70 mm |
| 3x  | 2x  |
| 9x  | 8x  |
| 5x  | 1x  |



- 3x** **A** min 68 mm | max 90 mm  240 cm
min 68 mm | max 90 mm
- 4x** **B** min 68 mm | max 90 mm  221 cm
min 68 mm | max 90 mm
- 2x** **C** min 68 mm | max 90 mm  190 cm
min 68 mm | max 90 mm
- 2x** **D** min 68 mm | max 90 mm  150 cm
min 68 mm | max 90 mm
- 2x** **E** min 68 mm | max 90 mm  min 212 / max 214 cm
min 32 mm | max 50 mm
- 8x** **F** min 68 mm | max 90 mm  min 199 / max 210 cm
min 32 mm | max 50 mm
- 2x** **G** min 68 mm | max 90 mm  min 138,5 / max 143 cm
min 32 mm | max 50 mm
- 2x** **H** min 68 mm | max 90 mm  min 67 / max 76 cm
min 32 mm | max 50 mm
- 2x** **I** min 95 mm | max 145 mm  min 138,5 / max 143 cm
min 15 mm | max 22 mm
- 20x*/28x**** **J** ** min 95 mm | * max 145 mm  80 cm
min 15 mm | max 22 mm
- 1x** **K** min 95 mm | max 145 mm  min 67 / max 76 cm
min 15 mm | max 22 mm
- 15x*/22x**** **L** ** min 95 mm | * max 145 mm  min 62 / max 66,5 cm
min 15 mm | max 22 mm
- 10x*/15x**** **M** ** min 95 mm | * max 145 mm  min 53,5 / max 58 cm
min 15 mm | max 22 mm

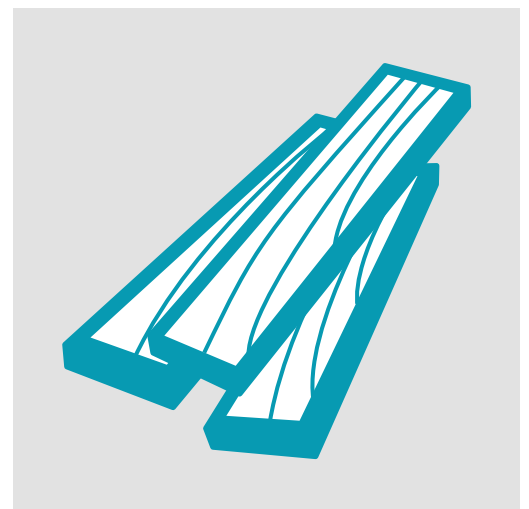



Blue Rabbit 2.0®
Hemelrijken 12
2890 Puurs-Sint-Amands
BELGIUM

www.bluerabbit.be
info@bluerabbit.be