



Pagoda

008.001.006.001



blue rabbit

© 2025

Blue Rabbit 2.0 - Hemelrijken 12 - 2890 Puurs-Sint-Amands - Belgium.
Copyrighted material - Do not reproduce under penalty of law.

①

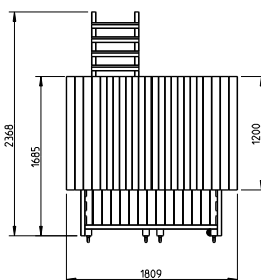
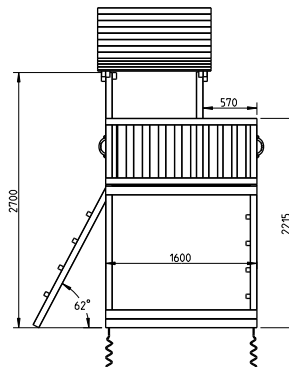
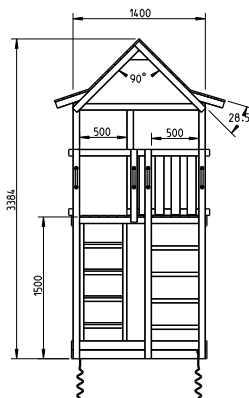

②

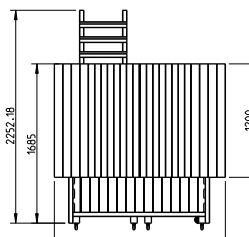
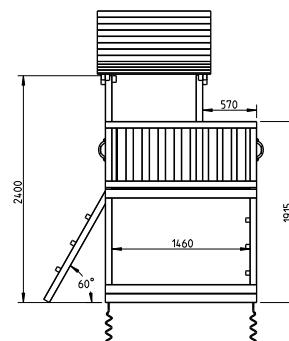
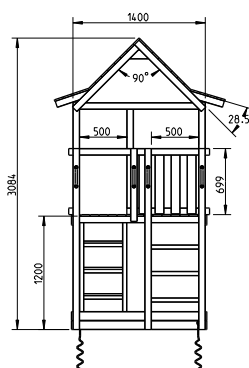

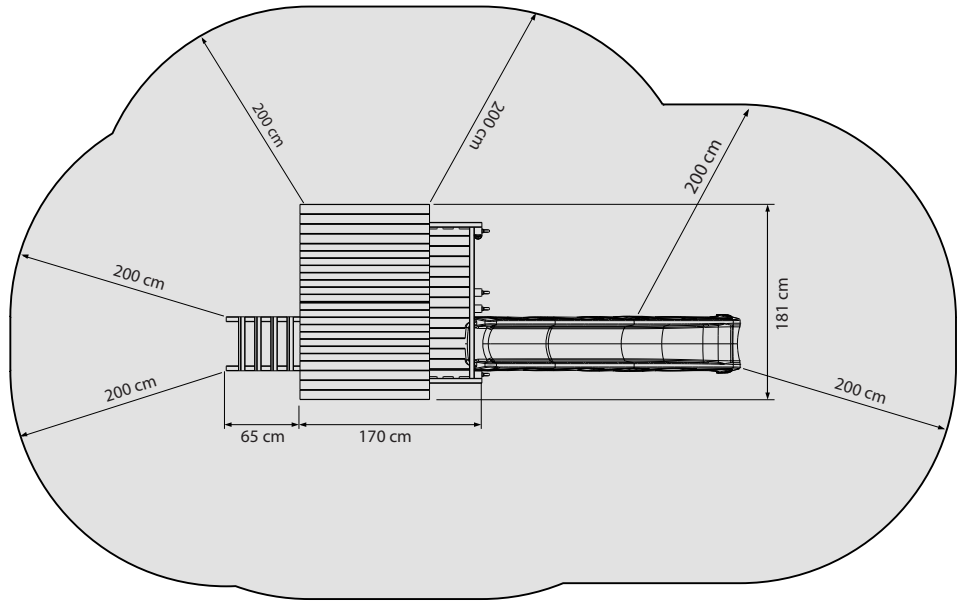
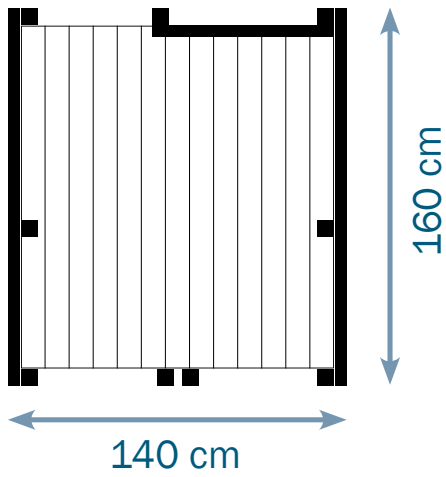

						@ramp 008.003.002.001		@challenger 008.003.007.001	
			@net 008.003.003.001	@bridge 008.003.004.001	@steps 008.003.008.001	@wall 008.003.001.001		@swing 008.003.005.001	
Pagoda 008.001.006.001	150 cm	X	(A) (B) (C)	(A) (B)	(A) (B)	X	(A) (B)	X	I II III IV
	120 cm	(A) (B) (C)	X	(A) (B)	X	(A) (B)	X	(A) (B)	X I II III IV

53 x 28 x 11 cm 6,3 kg

78 120 x 80 x 158 cm 516 kg

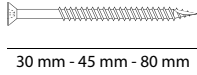
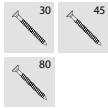

30 mm - 45 mm - 80 mm

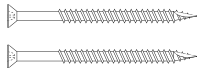
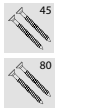

45 mm - 80 mm

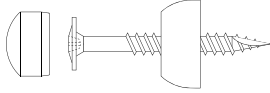

80 mm

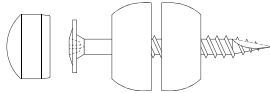

50 mm

4x

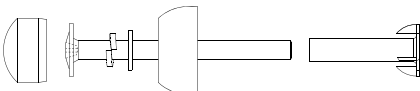

70 mm

4x

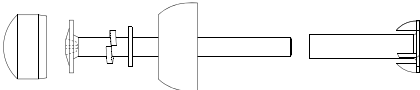

90 / 110 mm

2x

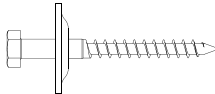

70 mm

6x



TX20



TX40



3









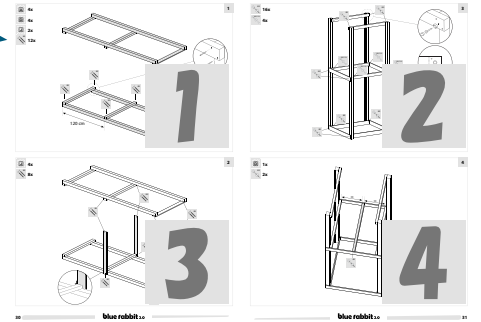



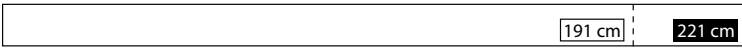

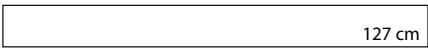

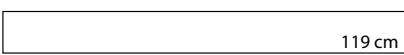

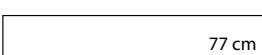

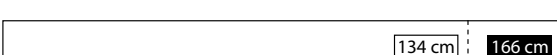

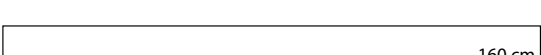

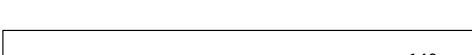

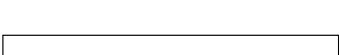

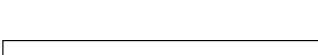









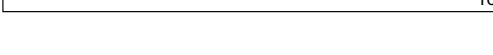

5

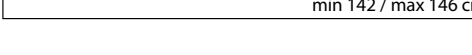

10

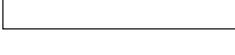

- 2x** **A** min 68 mm | max 90 mm  
min 68 mm
max 90 mm
- 3x** **B** min 68 mm | max 90 mm  
min 68 mm
max 90 mm
- 1x** **C** min 68 mm | max 90 mm  
min 68 mm
max 90 mm
- 2x** **D** min 68 mm | max 90 mm  
min 68 mm
max 90 mm
- 1x** **E** min 68 mm | max 90 mm  
min 68 mm
max 90 mm
- 2x** **F** min 68 mm | max 90 mm  
min 32 mm
max 50 mm
- 4x** **G** min 68 mm | max 90 mm  
min 32 mm
max 50 mm
- 6x** **H** min 68 mm | max 90 mm  
min 32 mm
max 50 mm
- 2x** **I** min 68 mm | max 90 mm  
min 32 mm
max 50 mm
- 2x** **J** min 68 mm | max 90 mm  
min 32 mm
max 50 mm
- 2x** **K** min 68 mm | max 90 mm  
min 32 mm
max 50 mm
- 4x** **L** min 68 mm | max 90 mm  
min 32 mm
max 50 mm
- 3x 4x** **M** min 44 mm | max 45 mm  
min 44 mm
max 45 mm
- 3x 4x** **N** min 44 mm | max 45 mm  
min 44 mm
max 45 mm
- 6x** **O** min 95 mm | max 145 mm  
min 15 mm
max 22 mm
- 10x*/15x**** **P** ** min 95 mm | * max 145 mm  
min 15 mm
max 22 mm
- 4x** **Q** min 95 mm | max 145 mm  
min 15 mm
max 22 mm
- 16x*/24x**** **R** ** min 95 mm | * max 145 mm  
min 15 mm
max 22 mm
- 15x*/20x**** **S** ** min 95 mm | * max 145 mm  
min 15 mm
max 22 mm
- 2x** **T** min 95 mm | max 145 mm  
min 15 mm
max 22 mm

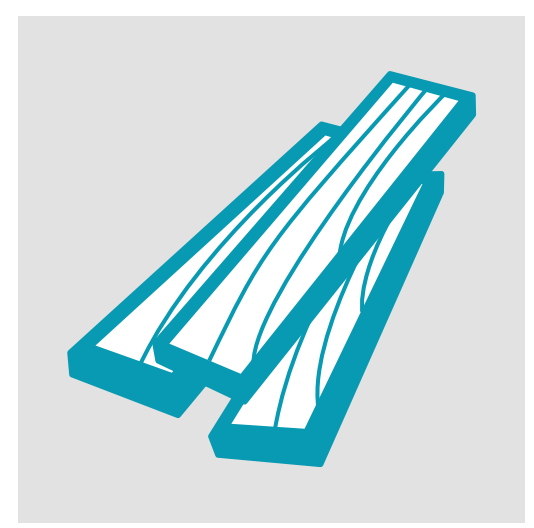
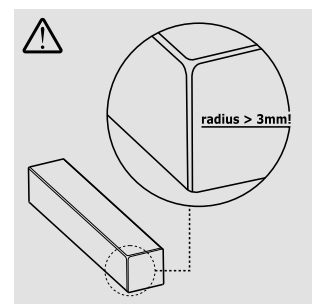
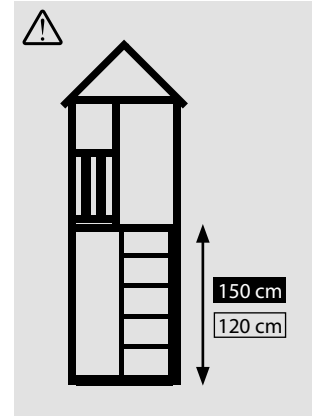



Blue Rabbit 2.0®
Hemelrijken 12
2890 Puurs-Sint-Amands
BELGIUM

www.bluerabbit.be
info@bluerabbit.be